



*Wiring Specifications  
for  
Data, Voice & CATV*

Tufts University, Version 6 © 2017

GENERAL TERMS AND CONDITIONS .....	4
1 USE OF THE WORK SITE .....	4
2 PENETRATIONS OF WALLS, FLOORS, CEILINGS .....	6
3 ROADWAYS AND PARKING AREAS .....	6
4 CONSTRUCTION PROCEDURES.....	7
5 MATERIALS.....	8
6 PLANNING AND DOCUMENTATION.....	9
7 LAWS, ORDINANCES, REGULATIONS, CODES, PERMITS AND STANDARDS 11	
8 REPORTS.....	13
9 CABLE REMOVAL .....	13
10 CLEAN UP .....	13
11 POLICE DETAILS .....	14
12 VOICE CUT-OVER.....	14
13 FINAL ACCEPTANCE .....	16
14 WARRANTY .....	16
15 GENERAL REQUIREMENTS.....	18
16 TELECOM OUTLETS .....	19
17 VOICE TERMINATIONS .....	23
18 DATA TERMINATIONS.....	23
19 CORDS .....	24
20 CABLE INSTALLATION .....	24
21 PANELS AND TERMINATING EQUIPMENT.....	27
22 EQUIPMENT RACKS .....	28
23 COPPER .....	28
24 FIBER .....	30
25 CONDUIT TYPES AND SUPPORTS .....	33
26 TELECOMMUNICATIONS ROOMS .....	40
27 GROUNDING AND BONDING REQUIREMENTS .....	42
28 FIRESTOP SPECIFICATIONS .....	45
29 CONDUIT DUCT BANK & MAINTENANCE HOLE SPECIFICATIONS .....	46
30 COMMUNITY ANTENNA TELEVISION "CATV" .....	52
31 AERIAL CABLE DESIGN & INSTALLATION .....	61

## INTRODUCTION

This Tufts University Data, Voice & CATV Wiring Specifications (“Specifications”) manual is incorporated by reference in each Master Services Agreement, and all work pursuant to each Master Services Agreement and Statement of Work shall be performed in accordance to these Specifications.

## **GENERAL TERMS AND CONDITIONS**

### ***1 USE OF THE WORK SITE***

- 1.1 THE CONTRACTOR SHALL CONFINE OPERATIONS AT THE SITE TO AREAS PERMITTED BY TUFTS AND SHALL NOT UNREASONABLY ENCUMBER THE SITE WITH MATERIALS OR EQUIPMENT.
- 1.2 ANY DAMAGE TO PERSONS OR PROPERTY RESULTING FROM THE CONSTRUCTION ACTIVITIES BEYOND THE LIMITS DEFINED IN THE CONTRACT DOCUMENTS SHALL BE THE SOLE RESPONSIBILITY OF THE CONTRACTOR.
- 1.3 STORAGE OF MATERIALS OR EQUIPMENT WILL NOT BE ALLOWED WITHOUT CONSENT OF TUFTS.
- 1.4 THE CONTRACTOR SHALL ENFORCE TUFTS INSTRUCTIONS REGARDING SIGNS, ADVERTISEMENTS, FIRES AND SMOKING. SHOULD ANY ROOM OR PART OF THE PROJECT BE TEMPORARILY USED BY THE CONTRACTOR AS SHOP, STOREROOM, LOCKER ROOM OR AN OFFICE, FOR ANY PURPOSE, SUCH ROOM OR PART OF SHALL, PRIOR TO COMPLETION AND WHEN DIRECTED, BE THOROUGHLY CLEANED, ALL DAMAGE ARISING THERE FROM MADE GOOD, AND THE WHOLE LEFT IN PERFECT CONDITION, BY THE PARTY OR PARTIES MAKING USE OF SAME. NO ROOM OR AREA SHALL BE USED WITHOUT THE CONSENT OF TUFTS.
- 1.5 THE CONTRACTOR SHALL PERFORM ALL WORK IN FULL COMPLIANCE WITH FEDERAL, STATE AND LOCAL HEALTH AND SAFETY REGULATIONS. ALL WORK HEREUNDER SHALL BE PERFORMED IN A SAFE MANNER. THE CONTRACTOR SHALL IMMEDIATELY SUSPEND AND CORRECT ANY DANGEROUS CONDITION CAUSED BY OR RESULTING FROM ITS WORK. IF THE CONTRACTOR FAILS TO CORRECT, OR TO ACT DILIGENTLY TO CORRECT ANY CONDITION WHICH TUFTS REASONABLY BELIEVES TO BE A HAZARD TO PERSONS OR PROPERTY, THEN TUFTS, UPON ORAL OR WRITTEN NOTICE TO ANY SUPERVISORY PERSONNEL OF THE CONTRACTOR, MAY, BUT SHALL NOT BE REQUIRED TO CORRECT THIS HAZARDOUS CONDITION AT THE CONTRACTOR'S EXPENSE. TUFTS SHALL CONFIRM IN WRITING ANY ORAL NOTICE GIVEN WITHIN FIVE (5) DAYS THEREAFTER.
- 1.6 WHERE ANY OF THE CONTRACTOR'S OPERATIONS OCCUR IN, ON OR WITHIN FIFTY (50) FEET OF ANY DOOR, WINDOW OR AIR INTAKE IN AN OCCUPIED BUILDING, THE CONTRACTOR SHALL, NOT LESS THAN TEN (10) DAYS PRIOR TO THE START OF ANY OPERATION, SHALL PROVIDE DIRECTLY TO TUFTS, SAFETY DATA SHEETS ON ALL MATERIAL, CHEMICALS, GASES, ETC., TO BE USED IN THE OPERATION WHICH ARE CLASSIFIED AS HAZARDOUS UNDER ANY FEDERAL, STATE OR LOCAL LAWS OR REGULATIONS.
- 1.7 THE CONTRACTOR SHALL NOT ROLL OR STORE CABLE REELS OR OTHER HEAVY MATERIALS/EQUIPMENT WITHOUT AN APPROPRIATE UNDERLAY AND THE PRIOR APPROVAL OF TUFTS OR THEIR REPRESENTATIVES.

1.8 IF APPLICABLE, NOT WITHSTANDING ANY OTHER PROVISION OF THE CONTRACT DOCUMENTS TO THE CONTRARY, THE CONTRACTOR, ONCE ITS ACTIVITIES BEGIN ON THE SITE, SHALL BE UNDER THE DIRECTION OF TUFT'S PROJECT MANAGER AND THE CONTRACTOR SHALL DIRECT ITS PERSONNEL AND SUBCONTRACTORS TO RESPECT AND ABIDE BY THE AUTHORITY OF THE TUFT'S PROJECT MANAGER ON ALL MATTERS RELATED TO THE CONTRACTOR'S OPERATION AT THE SITE, INCLUDING BUT NOT LIMITED TO:

- ❖ Using site resources such as elevators and loading docks, and the coordination of such usage by the Contractor, other Tufts subcontractors and other Tufts vendors.
- ❖ Connection to and use of utilities.
- ❖ Safety issues.
- ❖ Trash removal and site cleanliness.
- ❖ Site security.

1.9 THE CONTRACTOR ACKNOWLEDGES THAT THEY MAY BE PERFORMING WORK IN A BUILDING STILL UNDER CONSTRUCTION AND THEREFORE THE CONTRACTOR'S STAFF MUST ADHERE TO OSHA WORK-SITE REGULATIONS, OR ANY OTHER FEDERAL, STATE, LOCAL LAWS AND ORDINANCES. THE CONTRACTOR WILL BE RESPONSIBLE FOR FINES OR OTHER PENALTIES RESULTING FROM ANY VIOLATION THEREOF.

1.10 THE CONTRACTOR WILL BE HELD RESPONSIBLE FOR ANY AND ALL DAMAGES TO PORTIONS OF THE BUILDING CAUSED BY IT, ITS EMPLOYEES OR SUBCONTRACTORS; INCLUDING BUT NOT LIMITED TO:

- ❖ Damage to any portion of the building caused by the movement of tools, materials or equipment.
- ❖ Damage to any component of the construction of spaces "turned over" to the Contractor.
- ❖ Damage to the electrical distribution system and/or other space "turned over" to the Contractor.
- ❖ Damage to the electrical, mechanical and/or life safety or other systems caused by inappropriate operation or connections made by the Contractor or other actions of Contractor.
- ❖ Other damage to the materials, tools and/or equipment of Tufts, its consultants, other contractors, subcontractors, architect, agents and lessees.

## *2 PENETRATIONS OF WALLS, FLOORS, CEILINGS*

- 2.1 THE CONTRACTOR SHALL MAKE NO PENETRATION OF FLOORS, WALLS OR CEILINGS WITHOUT THE PRIOR CONSENT OF TUFT'S PROJECT MANAGER.
- 2.2 WHERE PENETRATIONS THROUGH ACOUSTICAL WALLS OR OTHER WALLS FOR CABLEWAYS HAVE BEEN PROVIDED FOR OR BY THE CONTRACTOR, THE CONTRACTOR IN COMPLIANCE WITH ALL APPLICABLE CODE REQUIREMENTS SHALL SEAL SUCH PENETRATIONS. SEALING SHALL BE EITHER UNDER THE DIRECTION OF TUFT'S PROJECT MANAGER. REFER TO NATIONAL FIRE PROTECTION ASSOCIATION (NFPA) LIFE SAVING CODE & ALL STATE/LOCAL CODES.
- 2.3 WHERE PENETRATIONS THROUGH FIRE-RATED WALLS FOR CABLEWAYS HAVE BEEN PROVIDED FOR THE CONTRACTOR, SUCH PENETRATIONS SHALL BE SEALED BY THE CONTRACTOR AS REQUIRED BY CODE AND AS DIRECTED BY TUFT'S PROJECT MANAGER. THE CONTRACTOR SHALL, PRIOR TO THE COMMENCEMENT OF ON-SITE ACTIVITIES, SUBMIT TO TUFTS FOR REVIEW, DETAILS OF ANY SPECIAL SYSTEMS TO BE USED. REFER TO NATIONAL FIRE PROTECTION ASSOCIATION (NFPA) LIFE SAVING CODE & ALL STATE/LOCAL CODES.
- 2.4 THE CONTRACTOR SHALL AT NO TIME DIRECT THE WORK OF TUFT'S OTHER CONTRACTORS, OR SUBCONTRACTORS, INCLUDING THE ELECTRICAL CONTRACTOR.
- 2.5 COMMUNICATION BETWEEN ANY OF TUFT'S OTHER CONTRACTORS OR SUBCONTRACTORS AND THE CONTRACTOR SHALL BE DIRECTED THROUGH TUFT'S PROJECT MANAGER. ANY REQUESTS FOR CHANGES IN THE WORK OF TUFT'S OTHER CONTRACTORS SHALL BE MADE THROUGH TUFTS.

## *3 ROADWAYS AND PARKING AREAS*

- 3.1 THE CONTRACTOR SHALL MAKE ADEQUATE PROVISIONS TO PREVENT UNNECESSARY INTERFERENCE WITH THE USE OF PUBLIC AND PRIVATE ROADS, WALKWAYS, DRIVES AND PARKING LOTS. THE CONTRACTOR SHALL PROVIDE AND MAINTAIN SUITABLE DETOURS OR OTHER TEMPORARY EXPEDIENTS IF NECESSARY. CLOSING OF ANY ROAD OR THE OBSTRUCTION OF FIRE LANES MUST BE COORDINATED WITH TUFTS AND THE APPROPRIATE FIRE AND SECURITY PERSONNEL.
- 3.2 THE CONTRACTOR SHALL REPAIR ROADS, WALKWAYS AND OTHER TRAFFIC AREAS DAMAGED BY THEIR OPERATIONS. THE CONTRACTOR SHALL KEEP TRAFFIC AREAS AS FREE AS POSSIBLE OF ANY SUPPLIES, EQUIPMENT OR EXCAVATED MATERIALS AND SHALL PROVIDE TRAFFIC BARRIERS, CONSTRUCTION SIGNS, WARNING LIGHTS, DIRECTIONAL SIGNS, DETOURS, GUARDS AND ALL OTHER DEVICES NECESSARY TO PROTECT THE PUBLIC. WHERE NECESSARY, PERSONNEL SUCH AS POLICE AND SECURITY PERSONNEL SHALL BE EMPLOYED TO DIRECT TRAFFIC THROUGH CONSTRUCTION AREAS. BRIDGING MATERIALS SUCH AS STEEL PLATES WILL BE PLACED OVER OPEN TRENCHES AND SHALL BE PROVIDED WHEREVER NECESSARY TO MAINTAIN THE FLOW OF TRAFFIC.

- 3.3 AT ALL TIMES WHEN WORK IS NOT ACTUALLY IN PROGRESS, THE CONTRACTOR SHALL MAKE OPEN, PASSABLE, AND MAINTAIN TO TRAFFIC SUCH PORTION OF THE WORK AND TEMPORARY ROADWAYS OR PORTIONS THEREOF AS MAY BE AGREED UPON BETWEEN TUFTS AND ALL OTHER AUTHORITIES OR PARTIES HAVING JURISDICTION OVER PROPERTIES INVOLVED.

#### 4 CONSTRUCTION PROCEDURES

- 4.1 THE CONTRACTOR, IMMEDIATELY AFTER EXECUTION OF THE CONTRACT DOCUMENTS, OR BEING AUTHORIZED BY TUFTS TO BEGIN WORK ON THE PROJECT, SHALL AT THE DIRECTION OF TUFTS AND WITHIN THE PRESCRIBED TIME LIMITS BE RESPONSIBLE FOR THE PREPARATION AND DELIVERY TO TUFTS ANY PROGRESS SCHEDULES OR SCHEDULE OF VALUES WHICH MAY BE REQUIRED BY TUFTS FOR THE WORK HEREIN SPECIFIED.
- 4.2 THE CONTRACTOR SHALL PERFORM THE WORK SO AS TO CAUSE A MINIMUM OF INCONVENIENCE TO OR INTERRUPTION OF TUFTS OR OTHER VENDORS' OPERATIONS. ANY AND ALL INTERRUPTION(S) OF TUFTS AND THEIR VENDORS' OPERATIONS, BUT NECESSARY FOR THE PERFORMANCE OF THE WORK, SHALL BE NOTED IN THE PROGRESS SCHEDULE. THE CONTRACTOR SHALL GIVE TUFTS AND ITS VENDORS SUFFICIENT ADVANCE NOTICE OF SUCH INTERRUPTIONS AS TO ALLOW TUFTS AND ITS VENDORS TIME TO ADJUST THEIR OPERATIONS. THE CONTRACTOR'S FAILURE TO SUPPLY TUFTS AND ITS VENDORS, WITH A TIMELY NOTICE OF SUCH INTENTIONS SHALL PLACE THE RESPONSIBILITY FOR ANY RESULTING DELAYS OR ADDITIONAL COSTS SOLELY WITH THE CONTRACTOR.
- 4.3 IF ANY TIME PRIOR TO COMMENCING, OR DURING THE PROGRESS OF WORK, THE LABOR, MATERIALS AND APPLIANCES USED OR TO BE USED, APPEAR TO TUFTS AS INSUFFICIENT OR IMPROPER FOR SECURING THE QUALITY OF WORK REQUIRED OR THE REQUIRED RATE OF PROGRESS, TUFTS MAY ORDER THE CONTRACTOR TO INCREASE EFFICIENCY, OR TO IMPROVE PROGRESS, AND THE CONTRACTOR SHALL CONFORM TO SUCH ORDER. THE FAILURE OF TUFTS TO MAKE SUCH A DEMAND SHALL NOT RELEASE THE CONTRACTOR FROM THE OBLIGATION TO SECURE THE QUALITY OF WORK OR RATE OF PROGRESS SPECIFIED.
- 4.4 IF AFTER SEVEN (7) DAYS WRITTEN NOTICE, THE CONTRACTOR FAILS TO CORRECT ANY VIOLATIONS OF THE PROVISIONS OF THE SOW OR SPECIFICATIONS OR TO MAINTAIN THE PROGRESS SPECIFIED IN THE PROGRESS SCHEDULE OR SCHEDULE OF VALUES, TUFTS MAY WITHOUT PREJUDICE OF ANY RIGHTS OR REMEDY IT MAY POSSESS, TERMINATE THE SERVICES OF THE CONTRACTOR IN WHOLE OR IN PART AND TAKE CONTROL OF THE WORK AS CONTEMPLATED BY THE CONTRACT DOCUMENTS BY WHATEVER METHOD DEEMED EXPEDIENT BY TUFTS.
- 4.5 THE COST OF SUCH COMPLETION INCURRED BY TUFTS IN THE EVENT OF TERMINATION IN WHOLE OR PART BASED ON ANY SUCH VIOLATIONS OR FAILURE TO MAINTAIN PROGRESS, SHALL BE THE RESPONSIBILITY OF THE CONTRACTOR.
- 4.6 AT THE WORK SITE, THE CONTRACTOR SHALL MAINTAIN AND MAKE AVAILABLE TO TUFTS, ONE (1) RECORD COPY OF ALL DRAWINGS, SPECIFICATIONS, ADDENDA, CHANGE

ORDERS AND OTHER MODIFICATIONS. THESE SHALL BE IN GOOD ORDER AND MARKED CURRENTLY TO RECORD ALL CHANGES MADE DURING CONSTRUCTION AND ALL APPROVED SHOP DRAWINGS, PRODUCT DATA AND SAMPLES. UPON COMPLETION OF WORK THESE DOCUMENTS SHALL BE DELIVERED TO TUFTS.

- 4.7 THE CONTRACTOR WILL BE RESPONSIBLE FOR ALL CUTTING, FITTING OR PATCHING THAT MAY BE REQUIRED TO COMPLETE THE WORK OR MAKE ITS SEVERAL PARTS FIT TOGETHER PROPERLY.
- 4.8 THROUGHOUT THE CONSTRUCTION PROCESS, THE CONTRACTOR SHALL FURNISH TUFTS ALL NECESSARY ASSISTANCE TO FACILITATE INSPECTIONS, OR FOR THE EXAMINATION OF ANY MATERIALS ENTERING INTO THE WORK, OR FOR ANY OTHER PURPOSE REQUIRED IN THE DISCHARGE OF TUFTS DUTIES.
- 4.9 WORKMANSHIP AND NEAT APPEARANCE SHALL BE AS IMPORTANT AS THE ELECTRICAL AND MECHANICAL EFFICIENCY OF THE SYSTEM.

## 5 MATERIALS

- 5.1 ALL MANUFACTURED ARTICLES, MATERIALS AND EQUIPMENT SHALL BE PROVIDED, APPLIED, INSTALLED, CONNECTED, ERECTED, CLEANED, CONDITIONED AND TESTED IN ACCORDANCE WITH MANUFACTURER'S PRINTED DIRECTIONS AND SPECIFICATIONS, UNLESS OTHERWISE SPECIFIED IN THE CONTRACT DOCUMENTS. WHERE SUCH DIRECTIONS ARE IN CONFLICT WITH THE CONTRACT DOCUMENTS, THE CONTRACTOR SHALL REPORT SUCH CONFLICTS TO TUFTS WHO SHALL MAKE SUCH COMPROMISES AS DEEMED NECESSARY AND DESIRABLE. ALL MATERIALS SHALL PERFORM AS NEW, SHALL CONFORM TO THE CURRENT APPLICABLE INDUSTRY STANDARDS, NEMA STANDARDS, AND SHALL BE UNDERWRITERS LABORATORIES STANDARDS LISTED AND LABELED UNLESS OTHERWISE INDICATED. DEFECTIVE OR DAMAGED MATERIALS SHALL BE REPLACED OR REPAIRED PRIOR TO FINAL ACCEPTANCE, IN A MANNER THAT MEETS THE APPROVAL OF TUFTS AND AT NO ADDITIONAL COST TO TUFTS. IN ADDITION, THE LATEST EDITIONS OF THE FOLLOWING STANDARDS ARE THE MINIMUM REQUIREMENTS:

- ❖ ASA Standards
- ❖ National Electric Code
- ❖ Local Codes
- ❖ Industry Standards
- ❖ All other applicable Standards

- 5.2 IT SHOULD BE NOTED THAT SOME OR ALL MATERIALS, METHODS AND SPECIFICATIONS MIGHT EXCEED ACCEPTED INDUSTRY STANDARDS. CONTRACTOR IS EXPECTED TO MEET ALL SPECIFICATIONS, AS WRITTEN, REGARDLESS OF WHETHER THEY EXCEED TUFTS OR ACCEPTED STANDARDS, NORMS, METHODS, OR PRACTICES.
- 5.3 THE TERMS "FURNISH", "PROVIDE" AND "INSTALL", WHEN USED IN THE CONTRACT DOCUMENTS SHALL BE INTERPRETED AS REQUIRING THE CONTRACTOR TO BOTH FURNISH AND/OR PROVIDE THE MATERIALS, AND INSTALL IT, UNLESS SPECIFIC



REFERENCE IS MADE TO THE FURNISHING OR INSTALLING OF THE MATERIALS BY OTHERS.

- 5.4 THE CONTRACTOR SHALL BE RESPONSIBLE FOR KEEPING ALL MATERIAL IN GOOD CONDITION UNTIL THE NOTICE OF FINAL ACCEPTANCE, BY:
- ❖ Taking any necessary steps such as painting, greasing, installation of rust preventative oil, covering etc. to protect all material from elements,
  - ❖ Protecting all cross terminals and other materials from corrosion etc., due to humidity, precipitation, temperature, atmospheric conditions and environment.
- 5.5 ADDITIONALLY, THE CONTRACTOR WILL BE RESPONSIBLE FOR THE ACCEPTANCE AND INVENTORY OF ALL MATERIALS AND, IF REQUIRED, WILL ACCEPT AND INVENTORY ANY SUPPLIES ORDERED BY TUFTS, IN REGARDS TO THE WORK.
- 5.6 IT SHALL BE THE RESPONSIBILITY OF THE CONTRACTOR TO FURNISH ANY SPECIAL INSTALLATION EQUIPMENT OR TOOLS NECESSARY TO PROPERLY COMPLETE THE WORK. THIS MAY INCLUDE, BUT IS NOT LIMITED TO, TOOLS FOR TERMINATING CABLES, TESTING AND SPLICING EQUIPMENT FOR COPPER/FIBER CABLES, COMMUNICATION DEVICES, JACK STANDS FOR CABLE REELS, OR CABLE WINCHES.
- 5.7 ANY ITEM OF EQUIPMENT OR MATERIAL NOT SPECIFICALLY ADDRESSED IN THE DRAWINGS OR IN THIS DOCUMENT AND REQUIRED TO PROVIDE A COMPLETE AND FUNCTIONAL PREMISES DISTRIBUTION SYSTEM INSTALLATION SHALL BE PROVIDED IN A LEVEL OF QUALITY CONSISTENT WITH OTHER SPECIFIED ITEMS.

## 6 *PLANNING AND DOCUMENTATION*

- 6.1 CONTRACTOR MUST ADHERE TO ALL DESIGN, ENGINEERING AND INSTALLATION PROCEDURES AND UTILIZE AUTHORIZED COMPONENTS IN PROVISIONING THE WORK.
- 6.2 THE PARTIES SHALL HOLD AN INITIAL PLANNING MEETING IMMEDIATELY AFTER EXECUTION OF THE CONTRACT DOCUMENTS TO CLARIFY ALL REQUIREMENTS (SYSTEMS, SERVICES, DISTRIBUTION METHODS, ETC.), IDENTIFY RESPONSIBILITIES, AND SCHEDULE THE EVENTS THAT WILL TRANSPIRE DURING THE IMPLEMENTATION OF THE PROJECT. WITHIN TWO (2) WEEKS OF THE INITIAL MEETING, THE CONTRACTOR SHALL PROVIDE A WRITTEN REPORT AND PROJECT SCHEDULE TO CLEARLY DOCUMENT THE EVENTS AND RESPONSIBILITIES ASSOCIATED WITH THE PROJECT.
- 6.3 UPON COMPLETION OF THE INITIAL ENGINEERING STAGE, AND PRIOR TO THE START OF CONSTRUCTION, THE SELECTED CONTRACTOR SHALL PROVIDE TWO (2) DRAFT COPIES OF ENGINEERING DOCUMENTATION (PRE-CONSTRUCTION DRAWINGS) FOR APPROVAL BY TUFTS. TUFTS WILL REVIEW THE ENGINEERING DOCUMENTATION WITHIN A TWO (2) WEEK PERIOD. IF NO REVISIONS ARE REQUIRED, THE DOCUMENTATION SHALL BE FORMALLY ACCEPTED IN WRITING BY TUFTS. ANY REVISIONS SHALL BE COMPLETED BY THE CONTRACTOR WITHIN A TWO (2) WEEK TIME PERIOD AND RESUBMITTED FOR

REVIEW. THESE PRELIMINARY DRAWINGS WILL BE IN A FORMAT ACCEPTABLE TO TUFTS.

6.4 UPON COMPLETION OF FINAL ENGINEERING, THE CONTRACTOR SHALL PROVIDE TO TUFTS, FOR ITS RECORDS, THE FOLLOWING:

- ❖ A detailed drawing of all telecom Rooms. These drawings will include all telecommunication and data components and/or apparatus that reside in these rooms. All cables terminated or spliced and their routes will be documented. The Contractor will provide to Tufts a detailed layout of all wall fields and frames.
- ❖ All cable routes from telecom outlet to termination field.
- ❖ Cross Connect Documentation - Provide cross connect records for all voice, and data devices, including detailed layout of termination fields and patch panels.
- ❖ Riser Distribution Plan that includes all riser cable routing.
- ❖ Cable Tray, Conduit, and Raceway Plans
- ❖ Campus Distribution Plan (if applicable)
- ❖ Building Control Plans in the following format:
  - One (1) set of computer files on CD's containing the drawings in AutoCAD format, or Visio, depending on Tufts requirements.
  - One (1) set of computer files of cross connects documentation on CD's in Excel form.

6.5 UPON COMPLETION OF THE PROJECT, THE CONTRACTOR IS TO PREPARE "AS BUILT" DOCUMENTATION WITH A MINIMUM OF TWO (2) POINTS OF REFERENCE FROM PERMANENT FIXTURES, BUILDINGS, PERMANENT WALLS, ETC.: SHOWING ACTUAL SITE CONDITIONS AND INSTALLATION AS CONSTRUCTED, AND PROVIDE COPIES OF SUCH DOCUMENTATION AS IS REQUIRED BY THE SOW AND THESE SPECIFICATIONS. FINAL CONTRACT PAYMENT IS CONTINGENT UPON EXECUTION BY TUFTS OF THE NOTICE OF FINAL ACCEPTANCE, AND SUCH FINAL ACCEPTANCE IS CONTINGENT UPON, AMONG OTHER THINGS, RECEIPT OF THE DOCUMENTATION.

6.6 IN ADDITION TO THE ENGINEERING DIAGRAMS, THE FOLLOWING ITEMS SHALL BE PROVIDED BY THE CONTRACTOR:

- ❖ Cable Records and Assignments
- ❖ Project Management

## 7 LAWS, ORDINANCES, REGULATIONS, CODES, PERMITS AND STANDARDS

7.1 NOT WITHSTANDING ANY OTHER PROVISION OF THE CONTRACT, THE CONTRACTOR REPRESENTS AND ACKNOWLEDGES THAT ANY SERVICES REQUIRED TO BE PROVIDED BY THE CONTRACTOR HEREUNDER WILL BE PROVIDED BY PERSONNEL KNOWLEDGEABLE OF ALL FEDERAL, STATE, COUNTY AND MUNICIPAL LAWS, REGULATIONS, CODES, ORDINANCES, INSURANCE RATING ORGANIZATION REGULATIONS AND ALL OTHER REGULATIONS AND PRACTICES APPLICABLE IN THE JURISDICTION IN WHICH THE WORK IS LOCATED, INCLUDING BUT NOT LIMITED TO, ALL HEALTH, SAFETY, ENVIRONMENTAL, BUILDING AND ZONING CODES, RULES AND REGULATIONS, AND BY THIS REPRESENTATION AGREES THAT SUCH LAWS, REGULATIONS, CODES, ORDINANCES, ORDERS AND RULES WILL BE COMPLIED WITH. THE CONTRACTOR AND THEIR REPRESENTATIVES SHALL ENSURE QUALIFIED TECHNICIANS, CERTIFIED AS REQUIRED BY TRADE COMPLETE THE INSTALLATION, AND THAT SUCH WORK IS PERFORMED IN A QUALITY AND WORKMAN LIKE MANNER. THE CONTRACTOR SHALL FURTHER ENSURE ALL MATERIALS AND EQUIPMENT ARE PLACED, MOUNTED CONNECTED, TERMINATED, SPLICED, CROSS-CONNECTED, GROUNDED AND TESTED IN ACCORDANCE WITH MANUFACTURER'S SPECIFICATIONS AND RECOMMENDATIONS IN STRICT COMPLIANCE WITH, INCLUDING BUT NOT LIMITED TO, NATIONAL ELECTRIC CODE, MASSACHUSETTS ELECTRIC CODE, CITY OR TOWN CODES, ANSI & OSHA STANDARDS AND FCC REGULATIONS. SHOULD THE CONTRACTOR FAIL TO COMPLY WITH THESE APPLICABLE LAWS, REGULATIONS, CODES, ORDINANCES, ORDERS, AND RULES, THE CONTRACTOR AGREES TO BEAR ALL COSTS INCURRED IN SECURING COMPLIANCE WITH SUCH LAWS, REGULATIONS, CODES, ORDINANCES, ORDERS AND RULES. THE CONTRACTOR'S ATTENTION IS DIRECTED TO THE FACT THAT ALL APPLICABLE STATE LAWS, MUNICIPAL ORDINANCES, RULES AND REGULATIONS OF ALL AUTHORITIES HAVING JURISDICTION OVER CONSTRUCTION OF THE PROJECT SHALL APPLY TO THE CONTRACT THE SAME AS THOUGH HEREIN WRITTEN OUT IN FULL.

7.2 THE FOLLOWING DOCUMENTS ARE A PART OF THESE SPECIFICATIONS AND SHALL INDICATE MINIMUM SAFETY PROVISIONS. ALL WORK CALLED FOR IN THESE SPECIFICATIONS AND/OR THE PLANS THAT EXCEED THE MINIMUM SAFETY PROVISIONS SHALL TAKE PRECEDENCE.

- ❖ National Electrical Code
- ❖ National Electrical Safety Code
- ❖ National Fire Protection Association
- ❖ State and Local Building Codes
- ❖ Occupational Safety and Health Act
- ❖ National Electrical Manufacturers Association
- ❖ BICSI Standards

- 7.3 REFERENCE TO STANDARD SPECIFICATIONS OF ANY TECHNICAL SOCIETY, ORGANIZATION, OR TO CODES OF LOCAL OR STATE AUTHORITIES, SHALL MEAN THE LATEST STANDARD, CODE, SPECIFICATION OR TENTATIVE SPECIFICATION ADOPTED AND PUBLISHED AT THE DATE OF TAKING BIDS, UNLESS SPECIFICALLY STATED OTHERWISE.
- 7.4 THE CONTRACTOR SHALL BE HELD TO BE FULLY INFORMED OF ALL FEDERAL, STATE AND LOCAL LAWS, ORDINANCES, BUILDING RULES/REGULATIONS AND OTHER STATUTORY PROVISIONS, ALL ARE APPLICABLE TO THE WORK AND TO ALL ACTIONS, OMISSIONS OR OPERATIONS IN THE PERFORMANCE OF THE WORK. THE CONTRACTOR SHALL COMPLY THEREWITH AND SHALL GIVE ALL REPORTS, STIPULATIONS AND REPRESENTATIONS REQUIRED THEREBY AND SHALL REQUIRE SIMILAR COMPLIANCE, REPORTS, STIPULATIONS AND REPRESENTATIONS BY ALL SUBCONTRACTORS AND OTHERS WHOM THE CONTRACTOR SHALL ENTER INTO ANY CONTRACT AND/OR COMMITMENT PERTAINING TO THE WORK.
- 7.5 IT SHALL BE THE DUTY OF THE CONTRACTOR, BEFORE STARTING ANY WORK, TO ASCERTAIN WHETHER THE SPECIFICATION(S) AND PROJECT DRAWING(S) ARE AT VARIANCE WITH ANY SUCH LAWS, ORDINANCES, RULES AND REGULATIONS OR OTHER STATUTORY PROVISIONS AND TO IMMEDIATELY NOTIFY TUFTS, IN WRITING, OF SUCH VARIANCES, SHOULD THEY EXIST, TO PERMIT PROPER DETERMINATION BY TUFTS AND TO ALLOW APPROPRIATE MODIFICATIONS AS MAY BE REQUIRED. IF THE CONTRACTOR PERFORMS ANY WORK KNOWING IT TO BE CONTRARY TO SUCH LAWS, RULES AND REGULATIONS AND WITHOUT SUCH NOTICE TO TUFTS, THE CONTRACTOR SHALL ASSUME FULL RESPONSIBILITY THEREOF AND SHALL BEAR ALL COSTS ATTRIBUTED THERETO.
- 7.6 WHERE THE CONTRACT REQUIRES THE WORK OR ANY PARTS OF SAME TO BE ABOVE THE STANDARDS REQUIRED BY APPLICABLE LAWS, ORDINANCES, RULES, REGULATIONS AND OTHER STATUTORY PROVISIONS PERTAINING TO THE WORK, THE CONTRACTOR WILL IMMEDIATELY NOTIFY TUFTS FOR CLARIFICATION.
- 7.7 ALL WORK AND MATERIALS WILL COMPLY WITH ALL STATE AND FEDERAL LAWS, MUNICIPAL ORDINANCES, REGULATIONS AND DIRECTION OF INSPECTORS APPOINTED BY PROPER AUTHORITIES HAVING JURISDICTION. IF THERE ARE VIOLATIONS OF CODE(S) THE CONTRACTOR WILL CORRECT THE SITUATION AT NO COST TO TUFTS. WORKING CONDITIONS MUST MEET INDUSTRY STANDARDS FOR SAFETY AND WORK PROCEDURES, AND PROTECTION OF PROPERTY ESTABLISHED BY PREVAILING RULES, REGULATIONS, ORDINANCES AND CODES.
- 7.8 ALL CONSTRUCTION SHALL CONFORM TO ALL FEDERAL, STATE AND LOCAL CODES AS THEY APPLY TO CONSTRUCTION OR WIRING. PARTICULAR CONSIDERATION IS TO BE GIVEN TO THE RESTORATION OF PENETRATED- FIRE AND SMOKE-STOP PARTITIONS AND FLOOR SLABS TO THEIR ORIGINAL CONDITION.
- 7.9 IF ANY HAZARDOUS MATERIAL, SUCH AS ASBESTOS IS ENCOUNTERED BY THE CONTRACTOR IN THE PERFORMING OF WORK, THEN THESE MATERIALS SHALL BE HANDLED IN ACCORDANCE WITH ALL APPLICABLE LOCAL, STATE OR FEDERAL LAWS,

STATUTES, OR ORDINANCES PERTAINING TO THESE MATERIALS. THE CONTRACTOR WILL IMMEDIATELY NOTIFY TUFTS OF ANY SUCH CONDITION.

- 7.10 NOTHING CONTAINED IN THIS DOCUMENT, SPECIFICATIONS, PLANS, SHALL BE CONSTRUED AS TO CONFLICT WITH ANY LOCAL, MUNICIPAL, STATE, FEDERAL LAW, OR REGULATION GOVERNING THE INSTALLATION OF TELEPHONE PLANT; ALL SUCH LAWS OR REGULATIONS ARE HEREBY MADE PART OF THESE DOCUMENTS. THE CONTRACTOR IS REQUIRED TO MEET THE REQUIREMENTS THEREOF WITHOUT ADDITIONAL EXPENSE OR HARM TO TUFTS. THE REQUIREMENTS OF ALL THESE CONTRACT DOCUMENTS ARE THE MINIMUM THAT WILL BE ACCEPTED.
- 7.11 WHERE REQUIRED, THE CONTRACTOR WILL PAY FOR THE SERVICES OF CITY/STATE POLICE, TUFTS SECURITY PERSONNEL OR OTHERS FOR THE PUBLIC SAFETY AND WHERE REQUIRED BY TUFTS/CITY/STATE ORDINANCES.

## **8** *REPORTS*

- 8.1 TEST REPORTS MUST BE SUBMITTED IN ELECTRONIC FORMAT. HAND-WRITTEN TEST REPORTS ARE NOT ACCEPTABLE.
- 8.2 TUFTS MAY REQUIRE HARDCOPY REPORTS, IF SO THEY ARE TO BE SUBMITTED IN LABELED 3 RING BINDERS WITH A WITNESS SIGNATURE VERIFYING PASSING AND EXECUTION OF ALL TESTS.
- 8.3 ELECTRONIC REPORTS MUST BE SUBMITTED IN CD FORMAT. CD'S SHALL CONTAIN THE SOFTWARE REQUIRED TO VIEW TEST RESULTS. ELECTRONIC REPORTS MUST BE ACCOMPANIED BY A CERTIFICATE SIGNED BY AN AUTHORIZED REPRESENTATIVE OF THE CONTRACTOR WARRANTING THE TRUTH AND ACCURACY OF THE ELECTRONIC REPORT. CERTIFICATE MUST REFERENCE TRACEABLE CIRCUIT NUMBERS THAT MATCH THE ELECTRONIC RECORD.
- 8.4 TEST REPORTS SHALL BE SUBMITTED WITHIN SEVEN (7) BUSINESS DAYS OF COMPLETION OF TESTING.

## **9** *CABLE REMOVAL*

- 9.1 CONTRACTOR SHALL REMOVE ALL ABANDONED TELEPHONE, COMPUTER, AND COAXIAL CABLE IN EACH BUILDING AS SPECIFIED BY THE TUFTS PROJECT MANAGER. ALL REMOVALS WILL BE ACCOMPLISHED BY WORKING FROM THE TELECOM OUTLET BACK TO THE TELECOM ROOM(S). THIS REMOVAL SHALL TAKE PLACE AFTER THE ACTIVATION OF ALL NEWLY INSTALLED CABLES AND EQUIPMENT. A BLANK PLATE SHALL BE PROVIDED AND INSTALLED BY THE CONTRACTOR TO FIT OVER OLD WORKBOXES.

## **10** *CLEAN UP*

- 10.1 DURING THE PERFORMANCE OF THE WORK, THE CONTRACTOR SHALL KEEP A REASONABLE DEGREE OF ORDER BY DISPOSING OF DAILY ACCUMULATED RUBBISH AND WASTE MATERIAL, AND AT THE COMPLETION OF THE DAILY WORK, THE SITE SHALL BE CLEARED OF ALL DEBRIS, LEFTOVER TOOLS, CONSUMABLE SUPPLIES AND MATERIAL

WHICH MAY HAVE ACCUMULATED AND LEAVE ALL AREAS OF THE WORK "BROOM CLEAN", OR ITS EQUIVALENT, UNLESS MORE EXACTLY SPECIFIED BY TUFTS. WHERE THE CONTRACTOR, AFTER RECEIPT OF WRITTEN NOTICE AS REQUIRED, FAILS TO KEEP THE AREA OF WORK REASONABLY CLEAN AND SAFE, OR FAILS TO CLEAN THIS AREA AT THE COMPLETION OF WORK, TUFTS MAY PERFORM OR HAVE THIS WORK PERFORMED BY OTHERS, THE COST OF WHICH SHALL BE AGAINST THE CONTRACTOR'S ACCOUNT AND MAY BE DEDUCTED FROM THE SUMS DUE OR TO BECOME DUE TO THE CONTRACTOR. IT WILL BE THE RESPONSIBILITY OF THE CONTRACTOR TO REMOVE THIS DAILY TRASH/DEBRIS OFF SITE. TUFTS BEARS NO RESPONSIBILITY TO PROVIDE SPACE FOR ON SITE DUMPSTERS OR OTHER TRASH RECOVERY SYSTEMS.

- 10.2 AT THE COMPLETION OF THE WORK, THE CONTRACTOR SHALL RESTORE TO ITS FORMER CONDITION ALL ASPECTS OF THE PROJECT SITE ON A DAILY BASIS, SHALL REMOVE ALL WASTE AND EXCESS MATERIALS, RUBBISH DEBRIS, TOOLS AND EQUIPMENT RESULTING FROM OR USED IN THE SERVICES PROVIDED UNDER THIS CONTRACT. ALL CLEAN UP, RESTORATION, AND REMOVAL NOTED ABOVE WILL BE BY THE CONTRACTOR AND AT NO COST TO TUFTS. IF THE CONTRACTOR FAILS IN ITS DUTIES UNDER THIS PARAGRAPH, TUFTS MAY UPON NOTICE TO THE CONTRACTOR PERFORM THE NECESSARY CLEAN UP AND DEDUCT THE COSTS THEREOF FROM ANY AMOUNTS DUE OR TO BECOME DUE TO THE CONTRACTOR. THE CONTRACTOR WILL PROVIDE DUMPSTERS FOR THE USE OF REMOVING TRASH OR DEBRIS. IT SHALL BE THE CONTRACTOR'S RESPONSIBILITY TO REMOVE TRASH FROM THE AREAS IT IS WORKING IN AND BRING TRASH AND DEBRIS TO THE DUMPSTER. THE CONTRACTOR WILL NOT USE ANY OF TUFTS DUMPSTERS OR TRASH DISPOSAL WITHOUT PRIOR APPROVAL OF TUFTS.

## *11 POLICE DETAILS*

- 11.1 THE CONTRACTOR SHALL BE RESPONSIBLE FOR PROVIDING AND ARRANGING POLICE DETAILS FROM CITY POLICE FOR TRAFFIC CONTROL AND PUBLIC SAFETY ISSUES WHEN WORKING OUTSIDE CAMPUS LIMITS.
- 11.2 THE TUFTS PROJECT MANAGER SHALL BE RESPONSIBLE FOR PROVIDING AND ARRANGING POLICE DETAILS FROM TUFTS POLICE FOR TRAFFIC CONTROL AND PUBLIC SAFETY ISSUES WHEN WORKING WITHIN CAMPUS LIMITS.

## *12 VOICE CUT-OVER*

- 12.1 MOST BUILDING VOICE CUTOVERS CONSIST OF THE FOLLOWING PRIOR TO A CUTOVER:
- ❖ Any cross wiring, TERMINATING or testing that can be done prior to cut over date shall be accomplished at least 3 days prior to cut over. All cut sheets to be provided by Tufts. All pre-cross wiring/testing will include all aspects of the project.
  - ❖ When required, Contractor will pre-terminate the BDF end of the voice tie cable from the outside plant protection 3 DAYS PRIOR TO CUT OVER.
- 12.2 MOST BUILDING VOICE CUTOVERS CONSIST OF THE FOLLOWING DURING A CUTOVER:

- ❖ Terminating the protection end of the voice tie cable.
- ❖ Careful visual inspections of each room to insure all voice requirements have been wired. This will include FAX, alarms, modems etc.
- ❖ Removal of telephone line cord from old jack and placing it into the new jack.
- ❖ While Contractor places existing telephone cord to new outlet, Contractor will check "old jack" to insure nothing is being fed from "old" outlet Voice# 2.
- ❖ Verification of proper operation of telephone set (set is working with no static) and that the proper number is assigned to the set. This will be verified by calling a digital display set, which shall be provided by Tufts.
- ❖ The Contractor shall keep track of time spent resolving troubles that are related to the outside plant portion of the cutover to be billed at hourly rate as quoted under unit prices.

12.3 MOST BUILDING VOICE POST CUTOVERS CONSIST OF THE FOLLOWING:

- ❖ Contractor will provide the minimum of two (2) workers on the first business day following a cutover. These workers will be responsible for all problems that relate to the work or testing.

## 13 FINAL ACCEPTANCE

- 13.1 ONCE ALL WORK HAS BEEN COMPLETED, TEST DOCUMENTATION HAS BEEN SUBMITTED, AND TUFTS IS SATISFIED THAT ALL WORK IS IN ACCORDANCE WITH THE CONTRACT DOCUMENTS, TUFTS SHALL PROVIDE CONTRACTOR WITH AN EXECUTED "NOTICE OF FINAL ACCEPTANCE."
- 13.2 EXPLANATION OF THE ITEMS INCLUDED AS PART OF THE FINAL ACCEPTANCE;
  - 13.2.1 As-built information:
  - 13.2.2 Workmanship Inspection;
  - 13.2.3 Electrical tests
- 13.3 IN THE INSTANCE WHERE ANY COMPONENT FAILS THE APPROPRIATE TEST, THE CONTRACTOR SHALL REPAIR THE FAULTY CIRCUIT AND RETEST.
- 13.4 IN ORDER TO SAVE TIME IT IS EXPECTED THAT THE CONTRACTOR WILL HAVE CHECKED THE WORKMANSHIP AND COMPLETELY CHECKED ALL CONNECTIONS PRIOR TO THE ACCEPTANCE TEST. TUFTS SHALL APPROVE THE ACCEPTANCE TEST METHOD BEFORE TESTING BEGINS. THE CONTRACTOR MAY BE REQUIRED TO REPEAT ANY TESTS WHICH WERE PERFORMED WITHOUT THE APPROVAL OF THE TUFTS PROJECT MANAGER. THE TEST SHALL BE DIVIDED INTO DISCRETE AREAS CORRESPONDING TO THE FLOORS, AND CAN BE PERFORMED IN ANY CONVENIENT ORDER.

## 14 WARRANTY

- 14.1 CONTRACTOR MUST WARRANT IN WRITING THAT 100% OF THE INSTALLATION MEETS THE STANDARDS AND REQUIREMENTS SPECIFIED.
- 14.2 ACCEPTANCE SHALL BE SUBJECT TO COMPLETION OF ALL WORK, SUCCESSFUL POST-INSTALLATION TESTING WHICH YIELDS 100% PASS RATING, AND RECEIPT OF FULL DOCUMENTATION.
- 14.3 TUFTS RESERVES THE RIGHT TO CONDUCT, USING CONTRACTOR EQUIPMENT AND LABOR, A RANDOM RE-TEST OF UP TO FIVE (5) PERCENT OF THE CABLE PLANT TO CONFIRM DOCUMENTED RESULTS. ANY FAILING CABLING SHALL BE RE-TESTED AND RESTORED TO A PASSING CONDITION. IN THE EVENT MORE THAN TWO (2) PERCENT OF THE CABLE PLANT FAILS DURING RE-TEST, THE ENTIRE CABLE PLANT SHALL BE RE-TESTED AND RESTORED TO A PASSING CONDITION AT NO ADDITIONAL COST TO TUFTS.
- 14.4 SYSTEM CERTIFICATION
  - ❖ Contractor shall warrant Installation against all product defects, and that all approved copper and fiber optic cabling components meet or exceed the requirements of this document for the extent of the respective Manufacturer's warranty period. Upon successful completion of the installation and subsequent inspection, the customer shall



be provided with a numbered certificate, from the manufacturing company, registering the installation.

## Wiring Specifications

---

### 15 GENERAL REQUIREMENTS

15.1 WIRING TOPOLOGY WILL BE STAR WITH “HOME RUN” CABLES FROM THE TELECOM ROOMS TO THE TELECOM OUTLETS. THE TUFTS PREMISE WIRING IS DESIGNED TO SUPPORT HIGH-SPEED DATA APPLICATIONS, USING UNSHIELDED TWISTED PAIR CABLING. THE TELECOM OUTLETS AND DISTRIBUTION FRAMES ARE ARRANGED ACCORDING TO THE SERVICE BEING PROVIDED.

#### 15.1.1 Jack and Cable Specifications and Colors

- ❖ Voice:
  - Cable - Approved 4 pair UL Category 6 CM, CMR, or plenum, Systimax Gigaspeed XL 1071E or 2071E, color White.
  - Outlet – MGS400-262, White
  
- ❖ VoIP:
  - Cable - Approved 4 pair UL Category 6 CM, CMR, or plenum, Systimax Gigaspeed XL 1071E or 2071E, color Green.
  - Outlet – MGS400-226, Green
  
- ❖ Data:
  - Cable - Approved 4 pair UL Category 6 CM, CMR, or plenum, Systimax Gigaspeed XL 1071E or 2071E, color Green.
  - Outlet – MGS400-226, Green
  
- ❖ Data Center:
  - Cable - Approved 4 pair UL Category 6 CM, CMR, or plenum, Systimax Gigaspeed XL 1071E or 2071E, color Gray.
  - Outlet – MGS400=270, Gray
  
- ❖ Wireless:
  - Cable - Approved 4 pair UL Category 6 CM, CMR, or plenum, Systimax Gigaspeed XL 1071E or 2071E, color Lilac.
  - Outlet – Direct termination of the cable with a RJ45 connector plugged directly into the access point. If an outlet is required, it shall be a MGS400-361, Violet in color.
  
- ❖ Video Security:
  - Cable - Approved 4 pair UL Category 6 CM, CMR, or plenum, Systimax Gigaspeed XL 1071E or 2071E, color Yellow.
  - Outlet – Direct termination of the cable with a RJ45 connector plugged directly into the camera. If an outlet is required, it shall be a MGS400-123, Yellow in color.

15.2 TUFTS PREMISE WIRING MUST CONFORM TO OR EXCEED ANSI/TIA STANDARD 568-C, THE APPROPRIATE UL STANDARD REQUIREMENT FOR EACH CATEGORY, AS WELL AS COMPLY WITH THE NATIONAL ELECTRICAL CODE, NFPA 70 (2017 EDITION), ARTICLE 800, AND ALL APPLICABLE STATE CODES AND LOCAL BUILDING CODES. ALL CABLE

MUST BE UL LISTED FOR THE INTENDED PURPOSE. ALL CABLING TYPES INSTALLED BY THE CONTRACTOR MUST BE ONE OF THE APPROVED TYPES AS LISTED BELOW. THE CONTRACTOR SHALL MAKE NO SUBSTITUTIONS IN CABLE TYPES UNLESS WRITTEN APPROVAL IS RECEIVED FROM TUFTS PROJECT MANAGER PRIOR TO THE INSTALLATION OF ANY SUBSTITUTE CABLE. CABLE TYPES SHALL BE CONSISTENT THROUGHOUT THE PROJECT.

15.3 CONTRACTOR MAY BE REQUIRED TO MOVE FURNITURE AND OTHER ITEMS FOR THE INSTALLATION OF CABLES AND OUTLETS. WHEN FURNITURE IS MOVED, IT WILL BE IMMEDIATELY RETURNED TO ITS ORIGINAL LOCATION WHEN THAT PARTICULAR OPERATION IS COMPLETED. FURNITURE WILL NOT BE LEFT FROM ITS ORIGINAL LOCATION FOR ANY EXTENDED LENGTH OF TIME, ESPECIALLY OVERNIGHT.

#### 15.4 LABELING

- ❖ All labeling shall be electronically printed.
- ❖ Font size 14 shall be used for patch panel labels
- ❖ Font size 20 shall be used for Telecom Outlet Face Plates
- ❖ All termination, protection, splice, patch panel hardware, etc. shall be labeled and the labels shall contain the distribution and feed points.
- ❖ All wireless access points shall have a TO I.D. label attached to the unit so that it is visible without disturbing the unit.

## 16 TELECOM OUTLETS

16.1 ALL DATA PRODUCTS TO MEET/EXCEED SYSTIMAX GIGASPEED XL SOLUTION, ALL WIRE IS 24 GAUGE 4 PAIR

#### 16.2 JACK COLOR CODE

- White – All voice (except Public Safety circuits)
- Green – Data and VoIP
- Yellow – Public safety
- Black – Video
- Gray – Data Center
- Red – Fire Alarm circuits
- Violet – Power over Ethernet / Wireless

16.3 STANDARD FACEPLATE CONFIGURATION FOR OFFICES, MEETING SPACES, ETC.

- ❖ 2-Systimax Approved 4 pair UL Category 6 CM, CMR, or plenum, Systimax Gigaspeed XL 1071E or 2071E, color Green, terminated with 2-MGS400-226, Green Information Outlets

#### Other Configurations

- ❖ Wall phones
  - 1- Approved 4 pair UL Category 6 CM, CMR, or plenum, Systimax Gigaspeed XL 1071E or 2071E, color Green

- ❖ Alarms
  - 1- Approved 4 pair UL Category 6 CM, CMR, or plenum, Systimax Gigaspeed XL 1071E or 2071E, color White (analog) & 2- Approved 4 pair UL Category 6 CM, CMR, or plenum, Systimax Gigaspeed XL 1071E or 2071E, color Green for Data
- ❖ Elevators
  - 1- Approved 4 pair UL Category 6 CM, CMR, or plenum, Systimax Gigaspeed XL 1071E or 2071E, color Green, with 1 – Surface Mount (Biscuit) Jack
- ❖ Emergency Phone (Ramtech)
  - 1-S Approved 4 pair UL Category 6 CM, CMR, or plenum, Systimax Gigaspeed XL 1071E or 2071E, color White
- ❖ Pay phones
  - 1- Approved 4 pair UL Category 6 CM, CMR, or plenum, Systimax Gigaspeed XL 1071E or 2071E, color White
- ❖ Stand Alone Fax
  - Cable - Approved 4 pair UL Category 6 CM, CMR, or plenum, Systimax Gigaspeed XL 1071E or 2071E, color White.
  - Outlet – MGS400-262, White
- ❖ Analog Credit Card Swipes
  - 1- Approved 4 pair UL Category 6 CM, CMR, or plenum, Systimax Gigaspeed XL 1071E or 2071E, color White
- ❖ Card Reader Control Panels
  - 1- Approved 4 pair UL Category 6 CM, CMR, or plenum, Systimax Gigaspeed XL 1071E or 2071E, color White (analog) & 2- Approved 4 pair UL Category 6 CM, CMR, or plenum, Systimax Gigaspeed XL 1071E or 2071E, color Green for Data
- ❖ Stand Alone Network Printers
  - 1- Approved 4 pair UL Category 6 CM, CMR, or plenum, Systimax Gigaspeed XL 1071E or 2071E, color Green
- ❖ Wireless
  - Cable - Approved 4 pair UL Category 6 CM, CMR, or plenum, Systimax Gigaspeed XL 1071E or 2071E, color Lilac.
  - Outlet – Direct termination of the cable with a RJ45 connector plugged directly into the access point. If an outlet is required, it shall be a MGS400-361, Violet in color.

#### 16.4 ICONS

- ❖ The following colored icons shall be installed for all MGS400 series outlets;
  - Voice – White
  - Data – Green

- Video – Black
- Fire Alarm circuits – Red
- Public Safety – Yellow
- Data Center – Gray
- PoE / Wireless – Violet

16.5 WALL PLATES

- The Contractor shall supply and install either “old work boxes” or “box eliminators” and install the appropriate Systimax wall plate and inserts. If “box eliminators” are used, prior to their installation Tufts must approve the type and installation method.
- Tufts will have a variety of wall plate configurations for desktop equipment, ranging from a single jack wall plate up to a 5 jack wall plate. The wall phone plates shall be mounted at 48” AFF. The standard wall plate shall be mounted 18 inches AFF. Work boxes and wall-plates for wireless access points shall be mounted 15” from the ceiling, or no higher than 12’ AFF.
- Marking of wall plates shall be with electronically printed labels. The top label shall list the proper Tuft’s building number (B for Boston, G for Grafton, M for Medford) followed by the jack number (i.e. M023-101-A, where M023 refers to Medford building number 023 and 101-A is the first outlet starting from left to right located in room 101) The labeling of jacks shall incorporate the room number followed by an alphabetical assignment (separated by a dash) starting from left to right as you enter the door (101-A, 101-B, 101-C) would indicate three jacks located in Room 101). The bottom label on each workstation outlet shall list of first termination point of the horizontal station cabling (i.e. an outlet labeled “TR Room 115” at the bottom of the outlet would indicate that the horizontal cabling to this outlet was terminated at TR Room 115). Tufts shall approve the labeling of workstation outlets before labeling is started.

16.5.1 Systimax Face Plates and inserts.

Item	Part #	Color	Part #
Face-Plate, Single Gang	M13FP-XXX	White	262
Face-Plate, Double Gang	M26FP-XXX	Black	003
Insert, 2 Port	M30FP-2RJ45-XXX	Ivory	246
Insert, 1 Port	M30FP-1RJ45-XXX	Gray	270
Insert, Blank	M30FP-1BLNK-XXX	Cream	215
The XXX represents the color			

### 16.5.2 Face Plate Jack Layout



## *17 VOICE TERMINATIONS*

- 17.1 VOICE TERMINATIONS AT THE DISTRIBUTION FRAMES SHALL BE MADE ON SYSTIMAX 110-HARDWARE AS SHOWN ON ASSOCIATED DRAWINGS. THE FRAMES SHALL BE LAID OUT IN SECTIONS, CORRESPONDING TO THE WORKSTATION LAYOUTS (I.E., AT THE TOP OF THE FRAME, ALL VOICE STATION CABLES, ROOM # & JACK NUMBER. THE JACK ORDER SHALL BE BY FLOOR, IN ASCENDING ORDER (I.E. 1ST FLOOR AT THE TOP, 2ND FLOOR NEXT, ETC.). 110 BLOCKS ON WALL FIELD SHALL BE SIZED TO ALLOW FOR 100% GROWTH FOR EXPANSION PURPOSES.
- 17.2 110A HARDWARE WILL BE EITHER 100 PAIR OR 300 PAIR. ALL CLIPS WILL BE 110C4 WITH 1-110C5 AT THE END OF EACH ROW.
- 17.3 ALL 110 HARDWARE VOICE STATIONS WILL BE LABELED WITH “WHITE” 110 STRIPS.
- 17.4 ALL PUBLIC SAFETY COPPER CIRCUITS WILL TERMINATE ON A SEPARATE 110 BLOCK WHICH WILL HAVE A YELLOW DESIGNATION STRIP. SPECIFIC CIRCUITS TO BE TERMINATED ON THIS BLOCK INCLUDE;
  - 17.4.1 Fire Alarm
  - 17.4.2 Burglar Alarm
  - 17.4.3 Ramtech Phones
  - 17.4.4 Carbon Monoxide (CO), Heat, & Smoke Detectors
  - 17.4.5 Red Emergency Phones
  - 17.4.6 Elevator Phones
  - 17.4.7 Panic Buttons

## *18 DATA TERMINATIONS*

- 18.1 DATA TERMINATIONS SHALL BE ON SYSTIMAX PATCH PANELS MOUNTED IN 19-INCH RACKS AS PER ROOM LAYOUT DIAGRAM, EITHER 24 OR 48 PORTS. DATA TERMINATIONS WILL BE INSTALLED ON SYSTIMAX VISI PATCH WHEN INDICATED.
- 18.2 ALL DATA STATIONS WILL BE LABELED PER TUFTS LABELING STANDARD WITH “GREEN” ELECTRONICALLY PRINTED STRIPS.
- 18.3 CABLES SHALL BE TERMINATED SO AS TO MAINTAIN THEIR TWIST TO WITHIN 1/2” OF THE IDC CONTACT. NO SPLICES WILL BE ALLOWED BETWEEN THE WORKSTATION OUTLET AND THE TELECOMMUNICATIONS WIRING ROOM.

## 19 CORDS

- 19.1 DATA STATION CORD - SYSTIMAX GS8E GIGASPEED XL MODULAR PATCH CORD (GRAY), STANDARD LENGTHS ARE 7' AND 14'. OTHER LENGTHS MAY BE SPECIFIED BY THE TUFTS PROJECT MANAGER.
- 19.2 EQUIPMENT CORD – SYSTIMAX GS8E GIGASPEED XL MODULAR PATCH CORD, GREEN FOR DATA, LILAC FOR POE, YELLOW FOR PUBLIC SAFETY, LENGTH SHALL BE APPROPRIATE FOR LOCATION AND NOT LONGER THAN ONE FOOT IN EXCESS.
- 19.3 ACCESS POINT CORD – SYSTIMAX GS8E GIGASPEED XL MODULAR PATCH CORD, LILAC

## 20 CABLE INSTALLATION

- 20.1 THIS APPLIES TO ALL VOICE/DATA/ALARMS/FAX/CIRCUITS ETC. THAT OPERATE OVER THE COPPER/FIBER SYSTEM THAT RESIDE IN THE BUILDING.
- 20.2 THE LENGTH OF EACH INDIVIDUAL RUN OF HORIZONTAL CABLE FROM THE TELECOMMUNICATIONS ROOM ON EACH FLOOR TO THE TELECOMMUNICATIONS OUTLET SHALL NOT EXCEED 295 FT (90 M).
- 20.3 EACH RUN OF CABLE BETWEEN THE TERMINATION BLOCK AND THE TELECOMMUNICATIONS OUTLET SHALL BE CONTINUOUS WITHOUT ANY JOINTS OR SPLICES.
- 20.4 IF THE INTERIOR OF WALLS ARE NOT OBSTRUCTED, THE CONTRACTOR SHALL CONCEAL HORIZONTAL DISTRIBUTION WIRING INTERNALLY WITHIN THE WALLS. IF SUCH OBSTRUCTIONS EXIST THEN THE CONTRACTOR SHALL SECURE APPROVAL BY TUFTS PRIOR TO THE USE OF ANY ALTERNATE METHOD SUCH AS WIREMOLD/CONDUIT ETC.
- 20.5 THE CONTRACTOR SHALL BE RESPONSIBLE FOR INSTALLING ALL REQUIRED CABLE ENTRANCE/EXIT HOLES, VERTICALLY AND HORIZONTALLY, UP TO AND INCLUDING 4". MOST OF THESE PENETRATIONS WILL BE FOR STATION TYPE CABLING AND WILL HAVE THE APPROPRIATE SIZE SLEEVE. ALL PENETRATIONS WILL BE FIRE SEALED PER NATIONAL ELECTRIC CODE AND ALL STATE & LOCAL CODES. ALL SLEEVES AND CONDUITS SHALL CONSIST OF EMT (UNLESS OTHERWISE NOTED) WITH NON-METALLIC BUSHINGS ON BOTH ENDS. ALL RACEWAY SYSTEMS SHALL BE METALLIC "WIREMOLD" BRAND. A VARIETY OF WIREMOLD SERIES, RANGING FROM SERIES 700 TO SERIES 4000 WILL BE USED, WHEN INDICATED. ALL WIREMOLD JUNCTION BOXES SHALL BE IVORY IN COLOR (UNLESS OTHERWISE SPECIFIED IN THE SCOPE OF WORK). SURFACE MOUNT WORKSTATION OUTLET BOXES SHALL BE WIREMOLD TYPE V5745 (IVORY). WIREMOLD SHALL BE CONTINUOUS WITHOUT GAPS. ALL ELBOWS, TEES, REDUCERS, ETC. SHALL BE MADE WITH "FACTORY MANUFACTURED FITTINGS", PROVIDED THAT THE MANUFACTURER MAKES THE SPECIFIC FITTING. APPLICATIONS USING "NON-FACTORY MANUFACTURED FITTINGS" ARE TO BE APPROVED IN ADVANCE BY THE TUFTS PROJECT MANAGER. NO CABLING SHALL BE EXPOSED UNLESS OTHERWISE SPECIFIED ON THE PROJECT PLANS.



- 20.6 HORIZONTAL WIRING FROM TELECOM ROOMS TO TELECOM OUTLETS SHALL BE 4 PAIR CABLES THE CONTRACTOR SHALL MAINTAIN DISTANCES FROM POWER AND LIGHTING CONDUCTORS AS SPECIFIED BELOW: STATION CABLES AND TIE CABLES INSTALLED WITHIN CEILING/WALLS/FLOOR/RISER SPACES SHALL BE ROUTED THROUGH THESE SPACES AT RIGHT ANGLES TO ELECTRICAL POWER CIRCUITS.
- Lighting - 12 "
  - Unshielded power cable > 2 KVA - 5"
  - Unshielded power cable > 5 KVA - 36"
- 20.7 COPPER CABLES SHALL BE ROUTED SO AS TO MAINTAIN A MINIMUM BEND RADIUS OF 6 TIMES THE CABLE DIAMETER. VELCRO WRAPS USED TO BUNDLE CABLES SHALL BE PULLED SNUG BUT NOT "CINCHED" SO THAT THE CABLES IN THE BUNDLE ARE NOT COMPRESSED. THE LENGTH OF THE VELCRO TIE WRAP SHOULD OVERLAP THE SIZE OF THE CABLE BUNDLE BEING WRAPPED BY 8" TO ALLOW FOR GROWTH. PLASTIC TIE WRAPS ARE NOT TO BE USED.
- 20.8 CABLE BUNDLES SHALL BE WRAPPED AT INTERVALS OF 18 IN. ALL CABLE RUNS SHALL BE PARALLEL OR PERPENDICULAR TO WALLS AND FLOORS. WHEN CROSSING CORRIDORS, CABLES SHALL BE TIED IN A BUNDLE AND SUPPORTED OVER THE CORRIDOR CROSSING SO THAT REMOVAL OF ANY TILE WILL NOT CAUSE THE BUNDLE TO DRAPE BELOW THE CEILING LINE. NO LOOSE CABLES SHALL BE LAID ON THE DROP CEILINGS. CABLES MUST BE AT LEAST 4" ABOVE REMOVABLE CEILING TILES.
- 20.9 AT NO TIME, EXCEPT DURING ACTUAL CABLE PULLING OPERATIONS, WILL CABLES BE LEFT "HANGING" OUT OF CEILINGS OR COILED IN HALLWAYS, OFFICES ETC. IF REQUIRED, CONTRACTOR WILL LEAVE SLACK/COILS ABOVE CEILINGS, PROPERLY MAINTAINING THEIR BEND RADIUS. IN TELECOM ROOMS, THE CONTRACTOR WILL NOT LEAVE CABLES ON THE FLOOR OR ALLOW CABLES TO HANG IN COILS. ALL SLACK IN CABLES WILL BE COILED AND LEFT ABOVE CEILING. DO NOT LAY DATA CABLES DIRECTLY ACROSS CEILING TILES, GRIDS, OR FIXTURES. USE CABLE TRAY OR OTHER METHODS TO SUPPORT THE CABLES AND KEEP THEM AT LEAST 6 INCHES ABOVE THE CEILING GRID.
- 20.10 DURING INSTALLATION, CONTRACTOR WILL PROTECT CABLES FROM BEING STEPPED ON. THIS APPLIES TO ALL AREAS, INCLUDING HALLWAYS AND TELECOM ROOMS.
- 20.11 ALL WIRING, INCLUDING COPPER AND FIBER JUMPERS, ETC. RUNNING ALONG THE WALL OR PLYWOOD BACKBOARD SHALL BE SECURED TO THE BACKBOARD OR WALLS OF THE TELEPHONE ROOMS/HALLWAYS, ETC., USING A METHOD TO BE APPROVED BY TUFTS. CABLE SUPPORTS SHALL BE USED TO PREVENT STRAIN ON THE CONDUCTORS, SUPPLEMENTED BY STRAIN RELIEF AT CONNECTOR TERMINATION POINTS. SUPPORT HORIZONTAL CABLE BUNDLES USING BROAD SUPPORTS LIKE J-HOOKS OR CABLE TRAYS. "BRIDLE RINGS" ARE NOT ALLOWED.
- 20.12 ALL STATION END CABLE BUNDLES SHALL HAVE AT LEAST 18" OF SLACK COILED UP AND STOWED IN AN AREA THAT IS ACCESSIBLE AND HIDDEN FROM VIEW. THIS 18" OF SLACK WILL BE AS CLOSE AS POSSIBLE TO THE STATION END OF THE RUN. AT THE TELECOM

ROOM END, THE CONTRACTOR WILL LEAVE 10' OF SLACK LOCATED AT OR NEAR THE TELECOM ROOM.

20.13 TO AVOID STRESSING CONDUCTORS, LIMIT PULLING TENSION TO 25 POUNDS OR LESS AS SPECIFIED BY THE ANSI/TIA-568-C STANDARD. IN ADDITION, PULL CABLES GRADUALLY AND WITH CONSTANT TENSION, TAKING CARE NOT TO CRUSH OR PINCH BUNDLES. BE PARTICULARLY CAREFUL WHEN PULLING CABLES AROUND CORNERS, WATCHING OUT FOR NAILS AND SHARP EDGES THAT COULD DAMAGE THE INSULATION.

20.14 THE CONTRACTOR SHALL MARK EACH CABLE SHEATH WITH THE ROOM, PLATE LETTER, AND CABLE TYPE AT THE END OF EACH CABLE (E.G. 101AV1 SIGNIFIES ROOM 101, PLATE A, VOICE 1 CABLE). ONLY INDELIBLE, CLEARLY PRINTED LABELS OR MARKINGS SHALL BE ACCEPTABLE.

20.15 WHEN CABLE LUBRICANT IS USED, READ INSTRUCTIONS TO BE SURE IT IS COMPATIBLE WITH THE CABLE'S JACKET MATERIAL (PVC OR FEP).

20.16 DO NOT SPLICE OR REPAIR DAMAGED CABLES BETWEEN THE TELECOM ROOM AND OUTLET LOCATIONS. IF REQUIRED, PULL A NEW CABLE.

20.17 USE GROMMETS TO PROTECT THE CABLE WHERE PASSING THROUGH METAL STUDS OR ANYTHING THAT CAN POSSIBLY CAUSE DAMAGE TO THE CABLES.

## 21 PANELS AND TERMINATING EQUIPMENT

- 21.1 EQUIPMENT RACK(S) FOR DATA WILL ACCEPT NINETEEN (19) IN. RACK MOUNTABLE, 24/48 -PORT 8-PIN MODULAR TO INSULATION DISPLACEMENT CONNECTOR (IDC) MEETING CATEGORY 6 PERFORMANCE STANDARDS, AND PINNED TO T568-C STANDARDS.
- 21.2 EQUIPMENT RACKS SHALL BE CHATSWORTH 7' X 19" (BLACK) WITH, CHATSWORTH 19" UPPER TRANSITION TRAY FOR FIBER OPTIC CABLES, CHATSWORTH 7'H X 6" DOUBLE SIDED WIDE VERTICAL CABLING SECTIONS, AND CHATSWORTH 12" CABLE RUNWAY RADIUS DROPS. ALL EQUIPMENT WILL BE COLORED BLACK.
- 21.3 TELECOM ROOM LADDER RACK / CABLE TRAY SHALL BE 12" BLACK (UNLESS OTHERWISE SPECIFIED). THE SECTION THAT LIES DIRECTLY OVER THE TOPS OF THE RACKS SHALL BE CHATSWORTH "ALTERNATE SPACE CABLE RUNWAY". RODS AND ANCHORS WILL SUPPORT RACK FROM CEILING, WALL PLATES WILL SUPPORT ALL ENDS THAT MEET WALLS. END CAPS WILL BE UTILIZED ON BOTH ENDS. EACH EQUIPMENT RACK SHALL BE SECURED TO LADDER RACK VIA CLAMPS AND RODS.
- 21.4 CABLE TRAY WILL BE CONTINUOUS FROM THE ENTRANCE POINT OF THE CONDUIT(S) OR SLEEVE(S) INTO THE TELECOM ROOM OVER TO THE TOP OF THE CABLING RACKS. REFER TO ROOM LAYOUT DIAGRAMS PROVIDED BY TUFTS FOR ADDITIONAL DETAIL.
- 21.5 SLEEVES SHALL BE 4" EMT WITH NON-CONDUCTIVE BUSHINGS ON EACH END INTO THE ROOM FOR HORIZONTAL CABLE ACCESS AS PER TELECOM ROOM LAYOUT DIAGRAM PROVIDED BY TUFTS. THE SLEEVES SHALL BE ATTACHED TO THE CEILING USING METAL STRUTS AND SUPPORTS AND THERE SHALL BE A MINIMUM OF 3" SEPARATION BETWEEN ADJACENT SLEEVES.
- 21.6 DATA
- ❖ Systimax 360 Gigaspeed XL Patchmax GS3 24 or 48 Port 2U Panel Kit
    - Product Numbers
      - 360-PM-KIT-2U-24
      - 360-PM-KIT-2U-48
  - ❖ One panel for all data terminations
  - ❖ One Panel for all POE devices, such as access points, IP cameras, etc.
- 21.7 VOICE WALL FIELD
- ❖ Systimax 110AB 100-FT or 300-FT

## 22 EQUIPMENT RACKS

- 22.1 THE STANDARD EQUIPMENT RACK SHALL BE THE CHATSWORTH 4-POST QUADRARACK. IF ADDITIONAL RACKS ARE REQUIRED THEY SHALL BE CHATSWORTH 2-POST 19" RACKS.

## 23 COPPER

### 23.1 RISER - VOICE OR OTHER ANALOG

- ❖ Systimax certified 24 gauge ARMM
- ❖ Systimax 24 gauge 1010 (PVC) or 2010 (Plenum) Refer to EIA/TIA 607 Grounding

### 23.2 SIZING

- ❖ Riser Sizing Should be based on total# of underground pairs, plus 50% growth rounded to the next 100 pair

### 23.3 CROSS WIRING

- ❖ Voice pairs will be cross wired as needed, not pre-wired.

### 23.4 BACKBONE

- 23.4.1 Solid copper, 24 AWG, twisted-pair backbone cable, in sizes as indicated on the drawings, with the following minimum/maximum specifications:

- ❖ Characteristic impedance -- 100 ohms at 1 MHz.
- ❖ Attenuation - 7.9 dB maximum per 1000 ft at 1 MHz.
- ❖ Listed Type CM, CMR, CMP, MPR and/or MPP (select cable type required).

### 23.5 IDENTIFICATION

- ❖ Provide pre-labeled cable count (House Count) instead of outlet number on riser patch panel.

### 23.6 LIGHTNING PROTECTION

- ❖ COMMSCOPE CARRIER SOLUTIONS | 4C1S | PROTECTOR MODULE 5 PIN COLOR BLACK SOLID STATE WITH HEAT COIL 300V

#### 23.6.1 Tufts Labeling Color Code

The following chart depicts the color coding for termination of all copper cables:

White	Voice Station Terminations, 1 <sup>st</sup> Level Backbone (ISP), House Riser
Gray	2 <sup>nd</sup> Level Backbone (OSP)
Green	Data Jacks, Wireless Jacks
Brown	Inter-Building Backbone (OSP)
Yellow	Public Safety (Alarms, Ramtech Phones, Smoke Detectors, Panic Buttons, Red Emergency Phones, Video Security, etc.)

### 23.7 COPPER TEST RULES

- ❖ Every pair in every cable will be tested and at a minimum will meet the standards of ANSI/TIA/EIA 568-C and above mentioned SYSTIMAX Specifications:
- ❖ No cabling or components shall be moved during the tests.
- ❖ In addition to pass/fail indications, the actual measured values (at whatever frequency taken) should be recorded in the administration system for use in future configuration or analyses of the premises network.
- ❖ NEXT and FEXT must be measured from both ends of a cable run.
- ❖ Reconfiguration will require re-testing.
- ❖ Qualified adapter cords shall be used to attach the test instruments to the link under inspection.
- ❖ In a channel, end-user patch cords shall be tested in place. End-user patch cords may be verified by inserting the user cords in the link under test at the cross-connect. Allowance will be made for 10 meters of equipment and patch cordage, and jumpers for the channel. (5 meters on each end is assumed).
- ❖ UTP test leads and associated connecting hardware to connect between the test equipment and the link under test, shall be 0.5 mm (24 AWG) and shall be taken from cable that meets or exceeds the requirements for Category 5e/CAT 6 cables specified in TIA-568-C.
- ❖ Coaxial cable assemblies between network analyzer and baluns should be as short as possible, preferably not exceeding 0.6 m (24 in) each.
- ❖ If a run barely passes (the result is within the tester's accuracy limit), the data must carry a warning (such as an asterisk) to indicate that the result was marginal
- ❖ The field tester must meet the ANSI/TIA-1153-2009

## 24 FIBER

All Fiber Optic components shall be Corning unless otherwise specified.

### 24.1 BACKBONE CABLE

- ❖ All fiber optic cable shall be Corning.
- ❖ Outdoor Fiber Optic Cable Shall Be Corning Altos sized appropriately.
- ❖ Indoor Fiber Optic Cable Shall Be Corning MIC Riser or MIC Plenum sized appropriately.
- ❖ All underground conduits shall be sealed with duct seal

### 24.2 INTRA-BUILDING BACKBONE REQUIREMENTS

- ❖ When fiber optic cable passes through a vertical riser room it should be secured to the wall every 48" or follow manufacturers recommendations.
- ❖ All fiber optic cables will be installed in Innerduct from point where it exits a room all the way to the point where it enters the next room unless otherwise specified by the Tufts Project Manager.
- ❖ Contractor must adhere to all manufacturer requirements regarding pulling tension and allowable lubricants of fiber and copper cables.
- ❖ Fibers must comply with EIA/TIA 492 specifications and IS 11801 standards.

### 24.3 INNERDUCT – DETECTABLE MAXCELL INNERDUCT SHALL BE PLACED FOR FIBER OPTIC INSTALLATIONS. SIZING SHALL BE SPECIFIED BY THE TUFTS PROJECT MANAGER.

### 24.4 CLOSURES AND SHELVES

- ☎ All shelves and closures shall be Corning as specified in the statement of work.

### 24.5 FIBER PATCH PANELS

- ☎ All PATCH PANELS will be Corning CCH unless otherwise specified.

### 24.6 FIBER OPTIC CONNECTORS

- ☎ All newly installed fiber optic cable shall have the ends fusion spliced to either a “CCH-CS12-A9-P00RE” or “CCH-CS24-A9-P00RE” as specified by the Tufts Project Manager.

### 24.7 RISER - FIBER



- ☎ Inner Duct

- Carlon 2" Corrugated (Riser Gard or Plenum Gard)
- Inner duct to be continuous with no splices
- Pull string to be left after installation of any cable

 Fiber

- Corning as specified in the scope of work
- Multi Mode 62.5, Single Mode 8.3

24.8 SIZING

-  Allow 12 strands per Telecom Room plus 24 spare in the BDF.
-  Allow 12 additional strands for any Phone switch installations.

24.9 PANELS

-  Corning as specified in the scope of the work

24.10 FIBER TESTING SPECIFICATIONS

 Fiber Testing General Requirements:

- One strand/termination per tube shall be tested with an OTDR both ways at 850 nm for Multi-Mode and 1310 for Single-Mode. In addition, each fiber shall be tested with a power meter for attenuation at 850 nm and 1300 nm for Multi-Mode, and 1310 and 1550 for Single-Mode. All terminations and splices are to have a maximum attenuation of less than or equal to .75 db per mated pair measured at 850 nm.
- The original OTDR traces, the power meter readings and the fiber cable manufacturer certifications shall be provided to Tufts as part of the as-built plans.
- Testing of all fiber strands installed as specified with test results shall be provided to the Tufts on diskette. Test details are listed under the acceptance test procedure located below.

24.10.1 Pre-installation cable testing –

The Contractor shall test all cable prior to the installation of the cable. The Contractor shall assume all liability for the replacement of the cable should it be found defective at a later date.

24.10.2 Loss Budget –

-  Fiber links shall have a maximum loss of: (allowable cable loss per km)(km of fiber in link) + (plus)(.4dB) (number of connectors) = (equals) maximum allowable loss

- ☎ A mated connector to connector interface is defined as a single connector for the purpose of this RFP
- ☎ Loss numbers for the installed link shall be calculated by taking the sum of the bi-directional measurements and dividing that sum by two.
- ☎ Any link not meeting the requirements of the standard (.75db per pair) shall be brought into compliance by the Contractor, at no charge to Tufts.

#### 24.11 OPTICAL FIBER CABLE TESTING WITH POWER METER

##### ☎ General Specifications:

- All testing shall be done in accordance with TIA-526-7 and TIA-526-14-D-2010.
- Multimode Horizontal Link Segments shall be tested in both directions at the 850-nm and 1300-nm wavelength.
- Multimode Backbone and Composite Link Segments shall be tested in both directions at both 850-nm and 1300-nm wavelengths.
- Single mode Horizontal Link Segments shall be tested in both directions at the 1310-nm and 1550-nm wavelength.
- Single mode Backbone and Composite Link Segments shall be tested in both directions at both 1310-nm and 1550-nm wavelengths.
- In compliance with TIA/EIA-526-14B “Optical Power Loss Measurements of Installed Multimode Fiber Cable Plant” and TIA/EIA-526-7 “Measurement of Optical Power Loss of Installed Single-Mode Fiber Cable Plant”, the following information shall be recorded during the test procedure:
  - Names of personnel conducting the test
  - Type of test equipment used (manufacturer, model, and serial number)
  - Date test is being performed
- Optical source wavelength, spectral width, and, for multimode, the coupled power ratio (CPR)
- Fiber identification
- End point locations
- Test direction
- Reference power measurement (when not using a power meter with a Relative Power Measurement Mode)
- Measured attenuation of the link segment (see Item 9.3)



## 24.12 ACCEPTABLE LINK ATTENUATION –

- ☎ Horizontal Link Segments are limited to 90 meters. Therefore, the acceptable link attenuation can be based on the longest installed link without introducing a significant error.

## 25 CONDUIT TYPES AND SUPPORTS

### 25.1 GENERAL REQUIREMENTS

- ☎ All new conduit, junction boxes and pull troughs will not interfere with existing equipment or block access to existing valves, pull boxes or any other type of equipment.
- ☎ Electrical Metallic Tubing (EMT) shall be standard straight (10'-0") lengths complying with UL standard UL 797.
- ☎ Fittings for EMT shall be compression type, dye cast, with insulated throat. Screw type or indenter connectors or couplings are not permitted.
- ☎ Where rigid conduit fittings are required, taper threaded hot dip galvanized steel fittings shall be used. Fittings shall be complete with sealing gaskets of a material suited to the environment in which they are to be used. No snap-on covers are to be used on fittings. Only fittings with covers fastened by captive screws shall be used. All fittings shall have integral bushings for the protection of the conductors.

### 25.2 RACEWAY SUPPORT

- ☎ Beam clamps shall be suitable for structural members and similar conditions.
- ☎ Clamps for attaching rigid conduit to structural members shall be galvanized U-bolts.
- ☎ Trapeze hangers shall use a channel erector system (Unistrut).
- ☎ Rods shall be galvanized steel or hot dipped (all thread), 3/8 of an inch diameter, minimum.
- ☎ Concrete inserts and raceway straps shall be galvanized.
- ☎ Steel bolts, nuts, washers and screws shall be galvanized.
- ☎ All 1 ¼" conduit routes shall not exceed more than 270 degrees of bends between pull points, 4" conduits routes shall not exceed more than 180 degrees of bends between pull points.

☎ Wherever required 24"X24"X8" junction boxes, 8"X8"X24" and 6"X6"X24" pull troughs will be installed. Assist boxes are to be installed every 100' for all conduit larger than 1 ¼", or prior to 270 degree bends.

☎ All conduit will have ¼" 800 lb test mule tape (condux #800200-02 or approved equal) installed.

### 25.3 CONDUIT RUNS

☎ Single Runs - Where conduits are run individually, they shall be supported by approved conduit clamps, secured by means of toggle bolts on hollow masonry, expansion shields and machine screws or standard preset inserts on concrete or solid masonry; machine screws or bolts on metal surfaces; and wood screws on wood construction. The use of perforated strap shall not be permitted. Where individual conduits are suspended from the ceiling, they shall be supported by conduit hangers, and rod.

☎ Multiple Runs – Where a number of conduits are to be run exposed and parallel one with another, they shall be grouped and supported by the structural steel or trapeze hangers.

### 25.4 CONDUIT APPLICATIONS

☎ Rigid steel galvanized conduit shall be used for all 1 inch exposed conduit, and 1 inch embedded unless otherwise noted on the drawings. Where required, low-level signal wiring shall be run in steel conduit regardless of size required.

☎ Liquid-tight flexible steel conduit shall be used for connections to computer lab furniture. Maximum length of (3'- 0") shall be used.

☎ Conduit interiors shall be protected from dirt, moisture, water and foreign substances during and after installation, prior to cable pulling, by installing flat metallic discs and steel bushings on each conduit end.

### 25.5 BENDS AND OFFSETS

☎ Contractor shall avoid using bends and offsets wherever possible.

☎ Manufactured 90 degree conduit elbows shall be used in conduit runs of 1- 1/2 inch trade size and larger whenever practical.

### 25.6 EXPOSED CONDUIT

☎ Exposed conduit shall be installed in neat and orderly rows, either parallel or perpendicular to walls, ceilings and structural members. Curved portions of concealed conduit shall not be visible where emerging from walls, slabs, ceilings.

- ☎ Conduit expansion joints shall be installed where straight conduit runs exceed 200' across building expansion joints or where indicated on the drawings.
- ☎ Conduit shall be installed at least (1'- 0") from steam or hot water piping in parallel runs, at least (6 inches) in cross-runs, and at least (3 inches) from all cold water piping.
- ☎ Threaded connections at conduit fittings and joints shall be sealed for low resistance, air and moisture tight connections.
- ☎ Where applicable, the use of dissimilar metals in contact anywhere in the system shall be avoided to eliminate the possibility of galvanic action. Where necessary, a coating of Galvicon or equal shall be applied.
- ☎ Conduit and conduit fittings shall not be welded to any structure.

## 25.7 CONDUIT AND FITTING REQUIREMENTS

- ☎ The following are considered standard conduit sizes which shall be used unless specified elsewhere:
  - 1"
  - 1 ½"
  - 2"
  - 3"
  - 4"
- ☎ Rigid steel conduit shall be full weight, heavy wall, hot dipped, galvanized and furnished in standard (10'- 0") straight lengths with a galvanized coupling on one end and a thread protector on the other. Fittings and boxes for rigid steel conduit systems shall be threaded hub, Crouse-Hinds Fer alloy type. Rigid aluminum conduit systems shall be threaded hub, Crouse-Hinds cast aluminum type.
- ☎ Rigid conduit hubs shall be Uni-Seal by Appleton or equal.
- ☎ Insulated grounding bushings shall be type GIB by Appleton or equal; where rigid conduit fittings are required, taper threaded hot dip galvanized steel fittings shall be used. Fittings shall be complete with sealing gaskets of a material suited to the environment in which they are to be used. No snap-on covers are to be used on fittings. Only fittings with covers fastened by captive screws shall be used. All fittings shall have integral bushings for the protection of the conductors.
- ☎ Electrical Metallic Tubing (EMT) shall be standard straight (10'- 0") lengths complying with UL standard UL 797.
- ☎ Fittings for EMT shall be compression type, dye cast, with insulated throat. Screw type or indenter connectors or couplings are not permitted.

- ☎ Conduit supports shall be according to Table 346-12 of the NEC. Outlet or connection boxes shall not be used for support of conduit. Supports shall be spaced a maximum of 3 feet from all fittings, elbows, outlet boxes, junction boxes, panels, motor control centers or any other terminal point.

## 25.8 CONDUIT, RACEWAY, HANGERS AND PULL BOXES

### 25.8.1 General Requirements –

- ☎ Install the conduit systems as close as possible to the detailed drawings.
- ☎ The installation shall be complete, including any additional pull boxes, hangers, and expansion joints required but not shown on drawings.
- ☎ Conduit runs may extend throughout the building from the outside plant entrance to the riser, and to the building customer's offices.
- ☎ Bending radius on all conduit shall be 10 X the diameter of the conduit unless indicated otherwise on the drawings or approved by P.M.
- ☎ A pull box shall be installed in each conduit run after a total of 180 degrees of conduit bends.
- ☎ Pull lines shall be placed in each conduit installed. In addition, label the conduit indicating that the conduit, raceway or pull box contains fiber optic cable or copper cables. The labels shall be placed every 10 feet on the conduit and on each pull box.
- ☎ Contractor shall replace at the Contractor's sole expense any existing items, materials and ceiling tiles damaged during installation.
- ☎ All products shall conform to applicable standards of the National Electrical Manufacturer's Association and the American National Standards Institute and shall be listed by Underwriter's Laboratory. All equipment must be identified by manufacturer.

### 25.8.2 Additional Material Requirements –

- ☎ Conduit: EMT, IMT, GRC, PVC and rigid aluminum conduit shall bear a UL label and be the size as indicated on the drawings.
- ☎ Hangers and Clamps: All hangers, clamps, fittings and rods shall be malleable steel and be either UL, NEMA, or ANSI approved.
- ☎ All hangers, clamps, fittings and rods shall be hot-dipped galvanized steel where subject to corrosion.
- ☎ Aluminum conduit hangers or factory plastic coated steel hangers are acceptable hangers for the installation of EMT, IMT or rigid aluminum conduit.

- ☎ Junction Boxes: All interior junction boxes shall be gray and conform to NEMA 1 unless otherwise specified and shown on the drawings. Box sizes shall be as indicated on the drawings.

## 25.9 TELECOMMUNICATIONS PREMISE WIRING CONDUIT REQUIREMENTS

- ☎ Provide system of conduit, outlets, pull boxes and mounting boards as specified and shown on the project drawings for voice and data systems.
- ☎ Each outlet box shall have a 1" conduit stubbed up with a bushing into the nearest accessible ceiling space. Conduits shall be of a size as indicated on the drawings, but shall not be smaller than 1" trade size in any event.
- ☎ Outlet boxes shall be 4 11/16" square with a single gang mud ring as specified on project plans.
- ☎ Where outlets are to be installed in existing, uninsulated gypsum board walls, a single gang old workbox shall be placed with a pull string to the closest accessible suspended ceiling space.
- ☎ Provide horizontal sleeves through firewalls for cable access. See cable fill requirements in ANSI EIA/TIA 569-C for sizing if sizing is not indicated on project plans.
- ☎ The exterior perimeter of all conduits and sleeves shall be fire-stopped as required to meet all local, state and national fire, electric and building codes. In addition, this fire stop system is subject to approval by the Tufts University Fire Marshall and Tufts Project Manager.
- ☎ Provide a system of cable trays or hangers above accessible ceiling suspended for all low voltage system cabling.
- ☎ All conduit runs from system outlets shall terminate above an accessible corridor suspended ceiling and shall terminate not more than 6" from a cable tray system above the accessible ceiling space. Provide sufficient cable supports to accommodate 3 times the cable to be installed, either by placing cable supports side-by-side or spaced vertically.
- ☎ Where corridors have non-accessible ceilings, provide conduit sleeves as a minimum (1) per system, covering the entire length of non-accessible ceiling cavity. Number and size of conduit/sleeves shall be per ANSI EIA/TIA 569-A cabling requirements.
- ☎ Ground all empty conduit and associated outlet boxes by #12 AWG copper insulated conductor to the nearest panel board ground bus. Provide insulated ground bushing at the end of each empty conduit run.
- ☎ Floor poke through fittings shall have a minimum space available for jacks of 2.75" W x 1.7" W x 1.2" D. Fittings must comply with NEC Article 300-21 and match fire resistance

rating of the floor. Fittings may be flush, pedestal, or furniture feeds as determined by Tufts.

- ☎ Substituted products must be electrically and mechanically interchangeable with the products listed herein. Samples and written approval of all substitutions shall be submitted for approval and may be rejected without appeal.



#### 25.10 WIREMOLD RACEWAY

- ☎ All exposed raceway systems in rooms shall be metallic “Wiremold” brand.
- ☎ The Contractor will furnish and install all required device plates associated with the Wiremold raceway. It will be the responsibility of the Contractor to match the existing raceway in size and color and to provide labor for the cutting in of all plates. All cutting of the existing raceway covers will be straight and all covers will fit flush to the adjoining piece.
- ☎ The typical device plate is a Wiremold V4007C-1. If a different size, type or color raceway is used, then the Contractor will provide the required plate to match the knockout dimensions of the aforementioned V4007C-1.
- ☎ Wiremold 700 and 2000 series and all Wiremold junction boxes shall be ivory in color.
- ☎ Surface mount workstation outlet boxes shall be Wiremold type V5745 (ivory) used in conjunction with Wiremold 2000, and V5744 (ivory) used in conjunction with 1” EMT conduit.
- ☎ Conduits, raceway systems, and Wiremold shall be continuous without gaps. All elbows, tees, reducers, etc. shall be made with “factory manufactured fittings”, provided that the manufacturer makes the specific fitting. Applications using “non-factory manufactured fittings” are to be approved in advance by the Tufts Project Manager.
- ☎ A 1 ¼ inch conduit shall feed each section of Wiremold 4000 raceway serving up to 8 voice/data cables. An additional 1 ¼ inch conduit shall be provided to the raceway for every additional 8 cables.
- ☎ Example:
  - For 1 to 8 cables, provide one 1 ¼ inch conduit
  - For 9 to 16 cables, provide two 1 ¼ inch conduits, etc.
  - These conduits shall be fed to opposite ends of the raceway system.
- ☎ Oversize single gang device kits shall be used for outlets when using Wiremold 4000 raceway (part number V4007C-1R gray) to accommodate voice/data jacks.
- ☎ No cabling shall be exposed unless otherwise specified on the project plans.

### 25.11 WIREMOLD FILL CAPACITY

Wiremold type	Maximum number of 4 pair cables per raceway
Wiremold 700	2
Wiremold 2000	15
Wiremold 3000	40
Wiremold 4000	72





### 25.12 VERTICAL CONDUITS

-  Vertical riser sleeves or conduits shall be a minimum i.d. size of 4 inches. A minimum of 2 sleeves per room shall be installed. Refer to riser conduit diagram provided by Tufts for quantities
-  Sleeves between floors in rooms shall terminate 1 to 3 in. above finished floor.
-  Insulated bushings must be provided on all sleeves.

### 25.13 FURNITURE SYSTEMS

-  It is important that the furniture used to provide these accommodations meets the requirements of ANSI/TIA/EIA-568-A, ANSI/TIA/EIA-569-A, TIA/EIA TSB75, and ISO/IEC 11801.

Furniture system telecommunications distribution planning and design should take into consideration the following guidelines:

-  Ensure that the overall furniture system planning has coordinated all the supporting functions including cable pathways for both telecommunications and power, outlets for both power and telecommunications devices, and connection of furniture pathways to horizontal building pathways.
-  Consult manufacturer information about intended applications of furniture systems, internal pathway capacity and bend radius, separation of power and telecommunications cabling, and any special tooling requirements.
-  The cross-sectional area of the straight section of a furniture pathway for telecommunications cabling must be at least 970 mm<sup>2</sup> (1.5 in<sup>2</sup> ). The minimum size pathway must not force the cable bend radius to be less than four times the cable diameter under conditions of maximum cable fill.
-  Where users need to frequently move desks or tables, it is preferable to locate outlets in furniture panels, walls, or other fixed locations rather than on desks or tables.
-  The Americans with Disabilities Act (ADA) may affect outlet-mounting locations in some instances. Other national regulations may apply.

- ☎ Refer to ANSI/TIA/EIA-569-A-2 for sizing of openings for mounting outlets in furniture systems
- ☎ Liquid-tight flexible steel conduit shall be used for connections to computer lab furniture. Maximum length of (3'- 0") shall be used.

## 26 TELECOMMUNICATIONS ROOMS

### 26.1 GENERAL REQUIREMENTS

- ☎ All telecom rooms shall have a card reader installed for access
- ☎ General requirements include a minimum of one Telecom Room per floor. Multiple Rooms are required if:
  - ☎ Usable floor space exceeds 10,000 sq. ft.
  - ☎ The cable length between the horizontal cross-connect and the telecom outlet, including slack, exceeds 295 ft. (90 meters).

### 26.2 SIZING

The following table contains the minimum room size requirements based on Serving area:

Serving Area	Minimum Room Size
5,000 sq. ft. or less	10 ft. x 10 ft.
5,000 to 8,000 sq. ft.	10 ft. x 10 ft.
8,000 to 10,000 sq. ft.	12 ft. x 12 ft.

### 26.3 PLACEMENT

- ☎ Telecom Rooms shall be located as close to the center of the serving area as possible in order to minimize cable lengths.
- ☎ In the situation of multiple floors, rooms shall be stacked vertically floor to floor.
- ☎ Under no circumstances shall the cable length between the horizontal cross-connect and the telecom outlet, including slack, exceed 295 ft. (90 meters).

### 26.4 BUILD OUT

- ☎ Telecom Rooms shall be a minimum height of 8 ft. 6 in.



- ☎ Install a sign on the wall outside the room that reads “Telecommunications Room” and has the room number on it.
- ☎ Install a smoke detector and tie it into the existing fire alarm system. It is recommended that the Contractor use the current Tufts fire system contractor.
- ☎ Floor treatment shall be VCT tile or non-static surface.
- ☎ Provide a NEC-approved copper grounding bar (Chatsworth Products Inc. – part # 10622-010) located at the top right hand side of the plywood backboard. The grounding bar shall be bonded with #6 copper wire to the building ground at the main panel. If equipment racks are used in the Telecommunications Room bonding between the copper ground bar and the rack(s) is to be provided.
- ☎ Use light colored paint on all walls and the plywood backboard. If the room will house Telecom equipment the walls shall be painted with at least two coats of fire-retardant paint.
- ☎ Provide a minimum switched fluorescent lighting of 500 lux (50 footcandles) measured 3 ft. AFF as per room layout. Lighting must be placed as not to cause any electrical interference to any telecom cabling. Refer to room layout diagram provided by Tufts for additional detail.
- ☎ Non-switched 20 amp 110v AC duplex utility outlets placed 12 inches AFF located around room perimeter 6 ft. on center. (see drawing for exact quantity and location)
- ☎ Two (2) non-switched 20-amp 110v 2-way hospital grade AC duplex outlets on separate dedicated circuits with isolated grounds. The two outlets can be contained in one quad workbox. The outlets shall be labeled “Circuit 1” and “Circuit 2”. The two dedicated breakers shall be labeled at the panel “Telecommunications Room - Circuit 1” and “Telecommunications Room - Circuit 2”. (see drawing for location and number of electrical outlets)
- ☎ Install 3/4 in. A/C painted plywood (8 ft. high by room width) directly to the wall. Mount plywood 6 in. off floor, and 6in. from room corners. The plywood shall be either fire-rated or treated on all sides with at least two coats of fire-resistant paint. Mount plywood on walls as shown on room layout diagram provided by Tufts.
- ☎ Provide and install a 12-inch wide continuous cable tray from the entrance point of the conduit(s) or sleeve(s) into the telecom room over to the top of the cabling racks. Refer to room layout diagrams provided by Tufts for additional detail.
- ☎ Provide and install a minimum of 3-4” EMT sleeves with non-conductive bushings on each end of the sleeve into the room for horizontal cable access as per Telecom Room layout diagram provided by Tufts. The sleeves shall be attached to the ceiling using metal struts and supports.

- ☎ Provide and install vertical riser sleeves (or conduits, if Telecom Rooms are not stacked) into room as per riser conduit diagram provided by Tufts.
- ☎ No wet piping shall be run through this room or in the ceiling area above. Sprinkler systems shall be dry-charge systems.
- ☎ A locking door to each Telecom Room shall be provided. The door shall be 3' x 80". The door shall not have a threshold. The lock shall be fitted with a secure core installed by the Tufts locksmith. The room shall be accessible by card reader only.
- ☎ Tufts will provide detailed room layouts once occupant capacity has been determined.
- ☎ Provide HVAC that will maintain continuous and dedicated environmental control by:
  - Maintaining positive pressure with a minimum of one air exchange per hour.
  - Temperature range between 64 & 75 degrees Fahrenheit.
  - Relative Humidity range 30 to 50%.

## 27 GROUNDING AND BONDING REQUIREMENTS

### 27.1 GROUNDING AND BONDING GENERAL REQUIREMENTS

- ☎ All service equipment's, conduit systems, supports, protectors, cabinets, cable sheaths, etc., shall be properly grounded in accordance with the latest issue of the National Electric, Local Codes and ANSI/TIA/EIA 607 Grounding and Bonding Practices. Contractor will provide all bonding wire, jumpers, grounding bushings, clamps, etc., as required for complete grounding. Ground wire will be routed to provide the shortest and most direct path to ground. All ground connections shall have clean contact surfaces. All ground wires will be labeled (tagged), colored and sized in accordance with ANSI/TIA/EIA 607, and the National Electric Code.

### 27.2 GROUNDING AND BONDING MINIMUM/MAXIMUM REQUIREMENTS

#### 27.2.1 Material Specifications:

- ☎ Unless otherwise specified, the IC (Interconnecting Bonding Conductor) (referred to in TIA/EIA-607 as the Bonding Conductor for Telecommunications) shall be insulated, copper, No. 3/0 AWG.
- ☎ Unless otherwise specified, the TBB (Telecommunications Bonding Backbone) shall be insulated, copper, No. 3/0 AWG.
- ☎ Unless otherwise specified, the EBC (Equipment Bonding Conductor) shall be green-colored insulation, copper, No. 6 AWG.

- ☎ Bonding conductors should not be placed in ferrous metallic conduit. If it is necessary to place bonding conductors in ferrous metallic conduit that exceeds 1 m (3 ft) in length, the conductors shall be bonded to each end of the conduit with a conductor sized as a No. 6 AWG, minimum (this makes the conduit a parallel path with the cable). Any grounding or bonding conductor which is run through a metallic conduit shall be bonded to the conduit at both ends.
- ☎ The TMGB will have a minimum of 6-mm thickness and 100-mm width; it should be electro tin - plated or cleaned prior to connecting the conductors to the bus bar. Just like the TMGB, the TGB should be at least 6-mm thick by 50-mm wide and electro tin - plated or cleaned prior to connecting the conductors to the bus bar.
- ☎ All insulated ground bars must be isolated from the structural support by a 2" minimum separation, using manufacturer's recommended insulating stand-offs and hardware.
- ☎ Contractor to furnish & install (1) TGB (Telecommunications Grounding Bus bar) in each IDF. Contractor to ground each TGB to building steel (if effectively grounded) via #6 ground wire.
- ☎ Bond the following to the TMGB when present:
  - Any electrical panel board for telecommunications that is located in the same room or space as the TMGB, said panel's Alternating Current Equipment Ground (ACEG) bus (when equipped) or the enclosure shall be bonded to the TMGB.
  - Telecommunication panel boards.
  - Building structural steel, if exposed (steel re-bars of reinforced concrete are not required to be bonded).
  - Metallic equipment racks & Cable Shield/Sheaths.
  - All metal raceways and cable trays for telecommunications cabling extending from the same room or space where the TMGB is located.
  - Outside plant cables & Protectors.

## 27.3 TELECOMMUNICATIONS ROOMS

### 27.3.1 General Requirements –

- ☎ All Telecommunications Rooms will adhere to the grounding guidelines set forth in TIA/EIA-607 (COMMERCIAL BUILDING GROUNDING AND BONDING REQUIREMENTS FOR TELECOMMUNICATIONS) plus any additional codes in Article (250 – GROUNDING) and (800 - COMMUNICATIONS SYSTEMS) of the NEC 2002.
- ☎ For an explanation of what constitutes a proper ground point for the Telecommunications bus bar to be attached to in a Telecommunications Room see NEC-2002 Article 800-40.

#### 27.4 ACCEPTABLE GROUND POINTS –

- ☎ The following three options are acceptable ground points, as long as they meet all of the detailed requirements of the above mentioned TIA/EIA-607 (COMMERCIAL BUILDING GROUNDING AND BONDING REQUIREMENTS FOR TELECOMMUNICATIONS) plus any additional codes in Article 250 – GROUNDING and 800 - COMMUNICATIONS SYSTEMS of the NEC 2002:
  - Attach to Building or Structure grounding system.  
or
  - Metallic power service raceway or equipment enclosure.  
or
  - Properly installed 8’ Ground rod to earth.

#### 27.5 SURFACE REQUIREMENTS:

- ☎ Any surface to be grounded must be free of paint or any other coating that may affect a proper ground to be achieved.
- ☎ The surface must be prepared to provide a proper path to ground.
- ☎ Paint should be scraped or filed away until a metallic surface has been exposed. Then the proper grounding component can be attached to complete the system.
- ☎ All system components (i.e. ladder-rack, equipment racks, etc.) will be connected together and eventually will connect to the TR’s Grounding Bus Bar with a minimum of a #6 solid or stranded copper wire with a green insulator.
- ☎ The Bus bar will be connected to the above mentioned building ground systems in such a manner as that it meets the above mentioned requirements set forth in TIA/EIA-607 (COMMERCIAL BUILDING GROUNDING AND BONDING REQUIREMENTS FOR TELECOMMUNICATIONS) plus any additional codes in Article (250 – GROUNDING) and (800 - COMMUNICATIONS SYSTEMS) of the NEC 2002. The Telecommunications Room Grounding Bus bar will attach to the above mentioned grounding system by a wire that is a minimum of # 6 solid or stranded green insulator copper wire.

#### 27.6 GROUNDING AND BONDING IN TELECOMMUNICATIONS ROOMS:

- ☎ All metallic racks, ladder ways and Network/Telecommunications Equipment will be properly terminated per TIA/EIA 607 and NEC 2002 guidelines and procedures.
- ☎ This Equipment will eventually be tied back to the TR’s Grounding Bus Bar that ties back to the Building’s Grounding System.

- ☎ The TR's Grounding Bus Bar shall be equipped with a grounding conductor that is attached to an approved electrode per NEC 2002 standards by a #6 copper wire with a green colored insulator.
- ☎ The wire jacket will be rated for the environment that it has been installed in. I.e. if the wire runs back to a ground electrode in a path through a plenum return airway then the cable should be plenum rated.
- ☎ No grounding/bonding conductors shall share the same connection at the bus-bar. Each grounding/bonding conductor shall terminate on its own "ground terminal block".

## 28 FIRESTOP SPECIFICATIONS

### 28.1 FIRESTOP GENERAL REQUIREMENTS

- ☎ The Contractor shall be responsible for providing a fire stop system composed of Hilti firestop products for all vertical and horizontal cable penetrations (THIS INCLUDES ALL STATION CABLING). This fire stop system shall meet all local, state and national fire, electric and building codes. The Contractor shall submit drawings showing the fire stop system to be used in each building for each type of penetration. This fire stop system is subject to approval by the Tufts University Fire Marshall and Tufts Project Manager.
- ☎ All horizontal sleeves used through Telecom Room walls shall be equipped with Hilti Firestop Speed Sleeve(s).



### 28.2 FIRESTOP STANDARDS

- ☎ For the interior of conduits and sleeves, the Contractor shall use a flexible, re-enterable approved fire stop compound (such as IPC FSP-1000 or equal). The fire stop material must meet the following Standards:
  - ASTM E814, Standard Method of Fire Tests of Through-Penetration Fire stops.
  - UL 1479, Fire Tests of Through-Penetration Fire stops.
  - UL Fire Resistance Directory: Through Penetration Fire stops Devices (XHCR) and Through Penetration Fire stop Systems (XNEZ).
  - ASTM E 119, Fire Tests of Building Construction and Materials (for fire-rated architectural barriers).
  - 2002 NFPA National Electrical Code, Section 800-52, Paragraph 2(b), Spread of Fire and Products of Combustion.
  - 1998 edition of the BICSI Telecommunications Distribution Methods Manual, Chapter 22, Fire stopping.
  - Factory Mutual Approval Guide.





- ULC List of Equipment and Materials, VOL. II.

## 29 CONDUIT DUCT BANK & MAINTENANCE HOLE SPECIFICATIONS

### 29.1 EXCAVATION

-  The Contractor shall be responsible for notifying Dig Safe. If available, refer to the plan labeled "UTILITY-SITE" for approximate locations of all known utilities. The Contractor performing the excavation shall have a qualified operator controlling all excavation equipment and in addition there will be a qualified laborer constantly viewing the excavation by the blade for any utilities. Shut offs and emergency blocking details shall be identified before excavation begins. The Contractor is responsible for complying with all trenching safety standards (OSHA, 441 CMR 10.00).
-  In the event the Contractor damages any utilities during excavation, the Contractor shall be responsible for securing qualified subcontractors to repair all damaged utilities. This repair work is subject to approval by Tufts.
-  The Contractor shall be responsible for securing the entire work area to insure public safety. Work areas shall be taped off at all times. All trenched areas left open at the end of the workday shall be covered with plywood. All vehicular pathways shall be covered with steel plates after excavation and prior to backfilling to provide access for vehicular traffic over the excavated area.

### 29.2 DUCT CONSTRUCTION

-  The Contractor shall supply and install conduits in the size and quantities as specified on the project plans. In the event that the conduits cannot be placed as shown on the project plans, the new placement shall be subject to approval by Tufts.
-  The Contractor shall submit samples of all materials for approval by Tufts prior to commencement of work.
-  Plastic conduit encased in concrete shall be type 40, rated for 90° C. Plastic conduit shall be composed of polyvinyl chloride, UL listed, and shall conform to NEMA standards and the National Electrical Code. The materials shall have a tensile strength of 6,000 PSI at 73.4°, flexural strength of 12,500 PSI, tensile modulus 470,000 PSI and a compressive strength of 9,000 PSI. Conduit sizes shown on project plans are measured by inside diameter. Plastic conduit, fittings, and elbows shall be produced by the same manufacturer. All joints shall be solvent welded in accordance with the recommendation of the manufacturer to provide a waterproof system.
-  Wood forms shall be installed by the Contractor on each side of duct sections before pouring concrete. Conduit(s) shall be placed on a layer of concrete prior to their initial set of not less than 3" thickness. The duct line shall be graded for drainage to prevent

pockets where moisture may accumulate. The Contractor shall construct the concrete encasement for the entire section of the underground duct bank.

- ☎ Conduit(s) shall be installed at a minimum depth of 24 inches (measured from the top of the conduit) below surrounding grade.
- ☎ Conduit(s) shall be placed approximately as shown on the project drawings using approved pre-cast spacers. Two (2) spacers shall be used per each ten (10) foot section of PVC conduit with the spacers being left in the concrete.
- ☎ Steel reinforcing rods shall be furnished and installed as shown on the drawings in any area of the conduit bank that runs underneath any road surface that is subject to use by vehicular traffic. The concrete shall be reinforced on the top and bottom of the encasement. The splice lap shall be 24 bar diameter and temperature reinforcements placed 24 inches o.c.
- ☎ The total number of bends in a conduit section shall not exceed two 90-degree bends or the equivalent of sweeps and radius bends. Each bend shall have a minimum inside radius of 10 times the internal diameter of the conduit.
- ☎ Encasement of ducts shall not commence until construction below finish grade has been approved by Tufts, the excavation cleaned of trash and debris, the final excavation level is firm and undisturbed, all duct system components have been installed, tested and approved, and the locations of all conduits and appurtenances have been recorded.
- ☎ Do not commence backfilling or encasement operations of utility trenches until all piping, etc., have been installed, tested and approved, and the locations of all pipe and appurtenances have been recorded.
- ☎ A “bright” colored, detectable (metallic) warning tape shall be placed 18” above the duct bank and run parallel (on top of) the duct bank for its entire length.
- ☎ Fiberglass measure pull strings shall be installed in each conduit and tied off at both ends. Conduits into buildings shall be fitted with removable plugs to prevent foreign matter from entering the building.
- ☎ Where conduit(s) turn up riser utility poles, conduit(s) shall extend 8 feet above grade. The exposed portion of conduit rising up the pole shall be metallic. Plugs shall be provided to seal conduits where they turn up.
- ☎ Where conduits turn up the exterior of buildings, they shall terminate in a metal pull box attached to the building placed above grade level. Penetrations and sleeves into the building from within this pull box shall be equal to the number and size of conduits entering the pull box from the ground.

### 29.3 MAINTENANCE-HOLES AND HAND-HOLES

- ☎ The Contractor shall supply and install maintenance-hole(s) and/or hand-hole(s) made of pre-cast concrete, to dimensions and specifications and in locations as shown on the project plans. In the event that a maintenance-hole/hand-hole cannot be placed in the area as shown on the project plans, the new location shall be subject to approval by the Tufts.
- ☎ The Contractor shall place the long axis of each new maintenance-hole parallel to the length of the larger duct line which is to enter the maintenance-hole, if possible.
- ☎ Maintenance-hole/hand-hole enclosures and covers shall be rated for no less than 5,000 lbs. over a 10" x 10" area and designed and tested to a temperature of -50F degrees. Material compressive strength shall be no less than 11,000 PSI. All maintenance-hole/hand-hole covers shall lie flush with the surrounding area when installed. In most roadway locations the maintenance hole rating shall be H-20.
- ☎ New maintenance-holes shall be equipped with: 30" round covers labeled "Tufts", and pulling eyes on all walls. Maintenance-holes shall have 2 sets of galvanized steel vertical racking (5 ft. high) installed along each end wall and 3 sets of galvanized steel vertical racking (5 ft. high) installed along each long wall. Two (2) eight (8) inch galvanized steel legs shall be supplied and installed in each vertical rack.
- ☎ Maintenance-hole construction joints shall be sealed with 1 in. diameter asphalt rope. The exterior perimeter of this construction joint shall be sealed with hydraulic cement after the maintenance-hole has been placed in its final position.
- ☎ New hand-holes shall be equipped with: 24" round covers labeled "Tufts" and pulling eyes on all walls. Hand-holes shall have 1 (one) set of galvanized steel vertical racking (2 ft. long) installed along each wall where conduit does not enter.
- ☎ A minimum of 6" of properly compacted structural fill shall be placed beneath each new enclosure.
- ☎ Maintenance-hole/hand-hole excavation and placement shall be scheduled so that the maintenance-hole is placed on the same day that the excavation for it is made.
- ☎ All penetrations of existing maintenance-holes/hand-holes shall be made using existing knockouts if possible starting at the bottom position and working up. Penetrations shall be centered in each end of the maintenance-hole. All conduits shall enter each maintenance-hole at a 90-degree angle to the side which they enter. Each conduit shall terminate into each maintenance-hole using a "bell" fitting. This "bell" fitting shall be sized to accept the same size conduit entering the maintenance-hole and shall be mounted flush with the interior wall of the maintenance-hole. Each penetration into the maintenance-hole (interior and exterior) shall be sealed with hydraulic cement to provide a waterproof seal and a smooth finish on the inside wall of the maintenance-hole.
- ☎ If the Contractor must break-out maintenance-hole walls, care must be taken to avoid disturbing existing services. If work in existing maintenance-holes/hand-holes will





disrupt or require movement of cables in existing maintenance-holes/hand-holes, Contractor shall give Tufts 48 hours notice before moving said cables. Contractor shall not intentionally cut or otherwise disrupt existing cables in maintenance-holes/hand-holes, whether deemed to be active or inactive by Contractor, without providing above notice to Tufts.

 A galvanized steel ladder shall be placed in each new maintenance-hole. The bottom legs of this ladder shall be attached to "L" shaped brackets attached to the floor of each maintenance-hole. The top of this ladder shall reach to within 2" of the top of the maintenance-hole cover. This ladder shall conform to ANSI A.14.1 - 1982(2), ANSI A.14.2 - 1982(3), ANSI A14.3 - 1984(4), or ANSI A14.5 - 1982(5).

 The Contractor shall supply and install maintenance-holes in the size, quantity and location as specified on project plans.

#### 29.4 BACKFILL

 Areas to be backfilled shall be free of construction debris, refuse, compressible or decayable materials and standing water. Do not place fill when temperature is below 30° F., and when fill materials or layers below them are frozen unless specifically approved by Tufts for the particular location.

 Any excavations in paved areas shall be backfilled with a minimum 8" of compacted suitable gravel backfill material. Compacted gravel fill shall consist of sand and gravel, crushed stone or other approved material.

#### 29.5 SURFACE TREATMENTS

##### 29.5.1 Paved areas:

 The work to be done consists of constructing Class "A" permanent patches over sewer, drain, water, and electrical conduit and structures in existing roadways, sidewalks, and parking lots and at all locations where existing bituminous is removed and replaced.

 Bituminous concrete shall be Class I bituminous concrete, Type I-I, furnished and laid in accordance with the Massachusetts Department of Public Works and Highways, Standard Specification for Road and Bridge Construction, latest edition, including all amendments thereto.

 Concrete shall conform to the relevant provision for high-early strength, Class A Concrete ASTM Type 3 Portland Cement with a minimum 28-day compressive strength 3,000 PSI. Cylinders six (6) inches in diameter by 12 inches in length shall be used to sample concrete from the truck. They shall be tested for compliance to the above specification with reports submitted to Tufts.

 All existing materials within the limits of the patch shall be removed to a depth of 24 inches below and parallel to the existing pavement grade. The satisfactory removal and disposal of all existing pavement and base material within 24 inches of the existing

surface shall be considered as included under this item and no additional compensation will be allowed therefore.

- ☎ Prior to the removal of the existing roadway pavement and/or base, the existing pavement and/or base shall be cut vertically with a saw. The cutting shall be in a straight line for the full depth of pavement and base to be removed. The existing pavement shall be cut back six inches from the existing base. No ragged or irregular edges will be permitted.
- ☎ All existing pavement and base material shall be removed and disposed of by the Contractor.
- ☎ Gravel base course shall be prepared according to the Standard Specifications.
- ☎ Upon the properly prepared and thoroughly compacted base course, 12 inches below and parallel to the abutting finished pavement surface, the Contractor shall place high early strength Class A cement concrete, to within 2 1/2 inches of finished grade. The concrete shall conform to ASTM C175 specifications for reinforced air-entrained concrete.
- ☎ The concrete base shall be covered with a binder course of 1-1/2 inches and a top course of 1 inch of bituminous each course placed in one layer. The courses shall be furnished and placed in accordance with ASTM C175 specifications.

#### 29.6 CONCRETE PAVEMENT AND WALKWAYS:

- ☎ Cast in place concrete shall be Class A, air-entrained concrete conforming to ASTM C175 specifications for minimum 28 day compressive strength 3,000 PSI concrete. Concrete shall be air-entrained 5% minimum with a 2 inch to 4-inch maximum slump.
- ☎ Wire mesh for reinforcement shall conform to AASHTO M55, latest requirements. The wire mesh size shall be WWF 6 In. x 6 in. 10/10. Wire mesh used for reinforcement shall be unrolled before placing in concrete. Mesh reinforcement shall be held firmly in place against vertical or transverse movement.
- ☎ Concrete pavement placement, curing, testing, reinforcing, protection and formwork shall be as specified in ASTM C175 specifications. Concrete shall have medium broom finish. No spray or curing compounds shall be used during construction of concrete base course.
- ☎ Expansion joints shall be placed where pavement meets structures, or twenty feet on center. Follow the manufacturer's application recommendations for joint filler and sealer. Expansion joints shall be a minimum of 1/2 inch wide. Slip dowels should be placed as required.

#### 29.7 REPLACEMENT OF SOD:

☎ New sod lawn shall be applied to affected lawn areas and any area identified by Tufts relating to the excavation. At least eight (8) inches of screened loam shall be added above the gravel backfill. Loam shall be fertilized, raked and sod added and rolled. New sod shall be watered daily for approximately 30 minutes for a period of three weeks. Final acceptance of sodded areas will be at the Universities discretion.

#### 29.8 REPLACEMENT OF SHRUBBERY:

☎ All shrubbery (includes all plant life) that is disturbed by this conduit project shall be restored to its previous condition. Final acceptance of shrubbery restoration will be at the Universities discretion.

#### 29.9 PERMITS

☎ The Contractor shall be responsible for securing any permits required for this project. The Contractor shall also be responsible for receiving a "DIGSAFE" number prior to any excavation.





#### 29.10 DOCUMENTATION

☎ The Contractor shall provide Tufts with as-built plans showing the location, size, depth, lengths, and quantities of conduits and maintenance-holes placed as part of this project.





☎ Note: A Utility site plan is available to all contractors from Tufts Buildings and Grounds Dept. that shows approximate locations of existing utilities.

## 30 COMMUNITY ANTENNA TELEVISION "CATV"

### 30.1 GENERAL PROCEDURES

-  It is extremely important that each job be evaluated prior to commencing construction. The proper materials, tools, and safety equipment must be used to perform each given task; this ensures a safe and efficient work environment.
-  Any changes made to a design will be indicated on the print and signed by the Tufts Project Manager. Contractor will not change the design without approval by Tufts Project Manager.
-  All installations shall be made in accordance with the National Electrical code version as adopted by the AHJ. A CATV fire resistant cable is to be used from tap to the TV set. For other uses such as risers, ducts, plenum, elevator shafts, and other air handling spaces, refer to approved cable types. All coaxial cables will be supplied by the Contractor.
-  All customer complaints and Tufts field requests must be addressed within 2 hours and must be completed within 24 hours.

### 30.2 PRE-PLANNING

-  Contractor will endeavor to meet the construction start and completion dates. If for any reason construction cannot be completed by the given date, Tufts will be notified in advance.
-  A meeting with the Tufts Project Manager, building Curator, Department Head and the Contractor must be arranged to inspect internal and external utilities, communications lines, sprinkler systems, landscaping, asphalt, concrete, and house lighting, etc. This will eliminate potential damage claims.
-  The Contractor is required to notify Dig Safe if excavation is necessary.
-  The building occupants, Management Staff, and the Curator or association must be notified five (5) working days prior to starting construction. This is to arrange access into each unit, if needed, and make personal changes to accommodate our construction needs.
-  The Contractor is to ensure that all materials are present before start of project so work can proceed in a timely manner.

### 30.3 SPECIFICATIONS AND MINIMUM REQUIREMENTS

-  Care and pride should be taken when routing exterior cables. Vertical and horizontal runs must be straight and neat.

- ☎ Take precautions to avoid kinking, crushing, stretching, or nicking the wire. If the cable is damaged during the installation procedure, it must be replaced back to the Telecom Room, pedestal, or lockbox.
- ☎ All Feeder drops must be securely fastened to the structure at intervals no greater than 30 inches. The fastened and/or anchor type shall be approved by the Tufts Project Manager prior to construction.
- ☎ The Feeder penetration shall be an angle drill from the outside. The penetration point on the inside of the building should be slightly higher than that of the outside; this is to prevent water from migrating along the cable into the structure. Contractor shall ensure that all power, telephone wiring, water pipes, pocket doors and gas lines in the walls are identified and protected. This shall include the use of mechanical blue prints, locators, ground fault interrupters and test holes.
- ☎ Use of molding riser to include the distribution cable and drop cables. Must have 6" drip loop at ALL entry points.
- ☎ All open ends and intersecting joints shall be mitered and sealed with silicone caulk.
- ☎ All exterior F-type connectors, splices and splitters should be of the outdoor type and properly weather sealed.
- ☎ All drops are to be tagged in lockboxes, pedestals, and Telecom Rooms.
- ☎ Each time a structure is penetrated, a feed through bushing must be used in conjunction with a silicone sealant.
- ☎ When cables are installed through fire walls, the walls must be sleeved with EMT conduit in accordance with NEC. Drops are then installed through the EMT and sealed with an appropriate fire stop.
- ☎ Wall plates are required for every outlet installation. Wall plates with an F-81 connector are to be mounted at the same height as the electric outlet or 14" from the floor to the bottom of the plate.
- ☎ When installing outlets on an adjacent wall a stud must separate all back outlets.
- ☎ If drilling through a carpeted floor becomes necessary, cut a small (1/2") "X" in the carpet before drilling. This will allow the drill to pass through the carpet without unraveling. A feed through bushing will seal the hole and hold down the carpet.
- ☎ If a wall fish is necessary, contact the Tufts Project Manager. Do not commence work without written permission.
- ☎ If the project has a bulk contract, the unit is vacant, or no television exists, a six foot jumper must be left.

- ☎ All tests will be performed using the full drop which is tap through wall plate including the jumper.
- ☎ All connections must be made from the wall plate to each TV and the picture quality must be acceptable to the Tufts Project Manager as well as all channels must be present. If the subscriber is present ask that they turn on the TV before hooking up the jumper to verify that the TV is operational.
- ☎ Install F-connectors on interior cable carefully and correctly, according to Drop Connector Specifications.
- ☎ All old wires, molding clips, screws and tie wraps must be removed from the structure. The holes must be patched and sealed.
- ☎ 75 Ohm port terminators will be installed on all unused tap ports.
- ☎ Every location will be installed on all unused tap ports.
- ☎ All equipment including actives and passives must be mounted to plywood backing when inside lockbox.
- ☎ All knockouts on lockboxes must be sealed with RTV.
- ☎ Drops will be tie wrapped together in the pedestal and lockbox in a neat and in orderly fashion. Tie-wraps shall be pulled snug but not so tight as to cinch the cable(s).
- ☎ Clean up any parts, tools or debris before leaving the unit/structure. Always leave the area you work in as clean as it was before you arrived.

#### 30.4 LOCKBOX LOCATIONS

- ☎ All lockboxes are to be installed according to the design provided by Tufts. Any changes will not be made without the written permission of the Tufts Project Manager.
- ☎ All lockboxes should be mounted 14' from ground level to the bottom of the box. Exceptions must be approved in writing by Tufts prior to placement.
- ☎ When mounting the lockbox, care should be taken not to obstruct any of the existing facilities. Minimum distance from existing boxes is 2".
- ☎ Each box must be securely fastened with an anchoring system approved by the Tufts Project Manager.
- ☎ All equipment, including actives, passives, deletion filters, signal processors, etc., must be mounted to the plywood backing.
- ☎ To accommodate future equipment changes, an excess of 12" shall be left on each drop.

- ☎ If a lockbox is being removed from the structure, the building must be patched and painted to match existing conditions as much as possible.
- ☎ If a lockbox is being replaced, install the new lockbox in the same location as the previous box. Any penetration or cracks caused by the box removal must be patched and sealed prior to installing the new box.
- ☎ The Tufts Project Manager must be contacted prior to removing a lockbox with an AC electrical outlet.
- ☎ All lockboxes will have a bead of RTV around it to seal it to the wall. All knockouts will have RTV.

### 30.5 WIRING STRUCTURE AND TOPOLOGY

- ☎ Wiring topology will be “Home Run” cables from the tap to the wall plates.
- ☎ Tufts premises wiring must conform to or exceed FCC Part 76, Title 29 CFR Parts 1901.1 to 1910.441 General Industry, (OSHA), Order No. 869-019-00111-5 Excavations (OSHA 2226), Order No. 029-01600125-5 Underground Construction (Tunneling) (OSHA 3115) Stairways and Ladders (OSHA 3124), the appropriate UL standard requirement for each category, as well as comply with the most current version of the National Electrical Code, articles 820 & 830, NESC Table 232-1 and all applicable state codes and local building codes. In addition:
  - All cable must be UL listed for the intended purpose.
  - All cabling types installed by the Contractor must be one of the approved types, as listed in these Specifications or the SOW.
  - The Contractor shall make no substitutions in cable types unless written approval is received from Tufts prior to the installation of any substitute cable. Cable types shall be consistent throughout the project and installed according to the Manufacturer’s specifications.
  - For all CommScope cables, refer to the CommScope Trunk and Distribution Cable Applications and Construction Manual, as well as the CommScope Broadband Applications and Construction Manual/Drop Cable.
  - Contractor may be required to move furniture and other items for the installation of cables and outlets. When furniture is moved, it will be immediately returned to its original location when that particular operation is completed. Furniture will not be left from its original location for any extended length of time, especially overnight.

### 30.6 AT THE TAP

- ☎ The following tasks will be performed at each tap:

- Tag the new drop and write the room number on it using a permanent marker.
- Connectors should be tightened to 20 inch pounds using a 7/16" open end torque wrench.
- Check and tighten any loose connectors.
- Terminate or cap and properly seal all unused spigots on the tap.

### 30.7 AERIAL INSTALLATION FROM POLE TO BUILDING

 The following areas are not to be crossed when placing an aerial drop:

- Properties other than Tufts.
- Swimming pools.
- Adjoining roofs, unless proper clearance is maintained.
- Electric or telephone service lines.
- Doors or windows.

\*In order to avoid these problems, sometimes a mid-span attachment will be necessary.

 Attachment to the structure should be made on the same side as the Power Service. Appropriate consideration should be given to possible obstructions. Structure attachment must have a one-foot clearance from power attachment on building.

 Structure attachment should be of sufficient height to ensure proper sag clearance from the ground.

 Do not lay out the cable where any vehicles could run over it. This will damage the dielectric and cause signal problems.

### 30.8 APPROVED CATV CABLE TYPES

 Drop (Indoor to TV Outlet):

- CommScope F6SSVR (RG6 SuperShield) for Riser, or CommScope 2227K (RG6 SuperShield) for Plenum

 Drop (Outdoor Pole to Building):

- CommScope F6SSVM (RG6 SuperShield Messenger)

 Room to Room Feeder:

- CommScope F11SSVR (RG11 SuperShield) for Riser or CommScope 2287K (RG11 SuperShield) for Plenum



- ☎ Aerial Distribution / Pole to Pole:
  - CommScope P3 500 JCA (Lashed to Strand)
- ☎ Aerial Distribution / Pole to Building:
  - CommScope P3 500 JCAM 109 (Self Supporting Messenger)
- ☎ Underground Distribution:
  - CommScope P3 500 JCASS
- ☎ Indoor/Riser Distribution:
  - CommScope P3 500 JCAR
- ☎ Aerial Trunk:
  - CommScope P3 750 JCA (Lashed to Strand)
- ☎ Headend:
  - CommScope F59 HEC-2

### 30.9 OUTLETS

- ☎ CATV Outlet – SYSTIMAX M81C 75 ohm threaded barrel connector

### 30.10 CATV CABLE TERMINATIONS

- ☎ All CATV terminations at the Telecom Room end and at the Wall Plate will be made using Belden Snap 'n' Seal F-Connectors. In the Telecom Room the terminated drops will be connected to an available tap port. If there are not any available tap ports, the Contractor is responsible to notify Tufts Project Manager so that a re-design may be done.
- ☎ All F-Connectors will be hand tightened at the Tap and the Wall Plate and then torqued to 20 lb. in. using a 7/16 torque wrench. No connectors will be wrench tightened to any equipment other than the Taps, Splitters, and Wall Plates. Never wrench tighten F-connectors to TV's, VCR's or any other subscriber equipment.
- ☎ All coaxial cable shall be prepared for F-Connectors with an approved Cable Prep tool designed for the size cable that was installed. No other method is acceptable.
- ☎ All outdoor connections shall be weather sealed using a method approved by Tufts.

### 30.11 CABLE ROUTING

- ☎ Do not leave extra cable for Tufts without permission from Tufts Project Manager.
- ☎ Any turns or bends in the cable, other than drip loops, should be a minimum of three inches in diameter. Don't drape the cable or make diagonal runs. Do not run cable in front of doorways or windows.

- ☎ The cable should be concealed wherever possible. The goal is to make the install as pleasing to the eye as possible, but also easily serviced by our technicians.
- ☎ If the structure has an unfinished basement, use it for cable routing when you can.
- ☎ When running a drop in an unfinished basement, attempt to follow the beams or joists.
- ☎ Do not run the cable diagonally or attach it to the bottom of the beams or joist in the event that a ceiling is put in at a later date.
- ☎ Do not run the cable through the same holes as the electrical wiring.
- ☎ Staples MUST NOT be used to support the cable. Staples can rip or cut into the jacket, allowing moisture to penetrate, as well as causing shorts, signal leakage, and changes to the electrical characteristics of the cable.
- ☎ Use only approved cable clips to support the cable.
- ☎ Avoid routing cable near baseboard heaters, hot water pipes, and hot air ducts. Over time, the heat will dry out the dielectric.
- ☎ Tie wraps used to bundle cables shall be VELCRO and pulled snug but not “cinched” so that the cables in the bundle are not compressed. The length of the VELCRO tie wrap should overlap the size of the cable bundle being wrapped by 8” to allow for growth.
- ☎ Contractor will endeavor to keep cables in bundles over the entire run. This is extremely important when entering or leaving Rooms.
- ☎ Cable bundles shall be wrapped at intervals of 18 in. All cable runs shall be parallel or perpendicular to walls and floors. When crossing corridors, cables shall be tied in a bundle and supported over the corridor crossing, so that removal of any tile will not cause the bundle to drape below the ceiling line. No loose cables shall be laid on the drop ceilings. Cables MUST BE AT LEAST 4” above removable ceiling tiles.
- ☎ At no time, except during actual cable pulling operations, will cables be left “hanging” out of ceilings or coiled in hallways, offices etc. If required, Contractor will leave slack/coils above ceilings, properly maintaining their bend radius. In terminal rooms, IDF’s/MDF’s, Contractor will not leave cables on floor or allow cables to hang in coils. All slack in cables will be coiled and left above ceiling. Do not lay cables directly across ceiling tiles, grids, or fixtures. Use cable tray or other methods to support the cables and keep them at least 6 inches away from fluorescent or HID light fixtures. Do not allow cables to cross power cables at right angles.
- ☎ During installation, Contractor will protect cables from being stepped on. This applies to all areas, including hallway and Telco Rooms.

- ☎ All wiring running along the wall shall be secured to the walls of the telephone rooms/hallways, etc., using a method to be approved by Tufts. Cable supports shall be used to prevent strain on the conductors, supplemented by strain relief at connector termination points. Support horizontal cable bundles using broad supports like J-hooks or cable trays. Avoid using narrow "bridle rings" since they tend to crush the cables.
- ☎ All cable ends at the Wall Plate shall have at least 6" of slack coiled up and stowed inside the wall box, and 12" of slack located at the Telecom Room.
- ☎ To avoid stressing conductors, limit pulling tension to 120 pounds maximum as specified by the manufacturer. In addition, pull cables gradually and with constant tension, taking care not to crush or pinch bundles. Be particularly careful when pulling cables around corners, watching out for nails and sharp edges that could damage the insulation.
- ☎ The Contractor shall mark each cable sheath with the room, plate letter, and cable type at the end of each cable (e.g. 101AV1 signifies Room 101, plate A, Voice 1 cable). Only indelible, clearly printed labels or markings shall be acceptable.
- ☎ When cable lubricant is used, read instructions to be sure it is compatible with the cable's jacket material (PVC or FEP).
- ☎ Do not splice or repair damaged cables between the telecom Room and outlet locations. You must pull a new cable.
- ☎ Use grommets to protect the cable where passing through metal studs or anything that can possibly cause damage to the cables.

### 30.12 TESTING CATV CABLES

30.12.1 Minimum Specifications – Contractor shall perform testing to insure all cables meet or exceed the following:

- ☎ Visual Signal Level –
  - Visual signal level, across terminating impedance which correctly matches the internal impedance of the cable system as viewed from the subscriber terminal, shall not be less than 1 millivolt across an internal impedance of 75 ohms (0 dBmV) at the highest frequency used in the system.
- ☎ System Noise –
  - The ratio of RF visual signal level to system noise shall not be less than 43 decibels at the wall plate.
- ☎ Low Frequency Disturbances (Hum or Repetitive transients) –
  - Low Frequency Disturbances, generated within the system, or by inadequate low frequency response, shall not exceed 3% of the visual signal level. Measurements made on a single channel using a single unmodulated carrier may be used to demonstrate compliance with this parameter at each wall plate.

 Signal Leakage –

- Signal Leakage from a cable television system shall be measured in accordance with the procedures outlined in 76.609(h) and shall be limited as follows:
  - Less than and including 54 MHz, and over 216 MHz – 15 microvolt per meter @ 30 meters.
  - Over 54 up to and including 216 MHz – 20 microvolts per meter @ 3 meters.
  - Contractor will provide test results per FCC Part 76.605 Technical Standards.

### 30.13 GROUNDING AND BONDING

 All grounding and bonding shall comply with NEC article 820.

### 30.14 DOCUMENTATION

 The Contractor shall furnish a set of as-built premise wiring drawings, showing the actual cable paths and outlet locations. As-built information shall be completed prior to system acceptance testing.

### 30.15 ACCEPTANCE TEST CATV PREMISE CABLING

 The acceptance test includes the following three parts:

- Verification of as-built information
- Workmanship inspection
- Electrical tests

#### 30.15.1 Verification of as-built information –

 The acceptance test will include verification of the as-built information red-marked by the Contractor on drawings supplied by Tufts for that purpose.

#### 30.15.2 Workmanship inspection –

 All cable runs, wall plates and distribution frames shall be inspected. The workmanship part of the Acceptance Test includes inspection of wires for mechanical damage (cuts and abrasions, rushed segments, crushed or cracked connectors), spacing, and routing.

#### 30.15.3 Electrical Tests –

 Electrical tests will identify shorted cables, open cables, high resistance, faulty connections, and incorrectly labeled connections, as well as verifying that the wiring installation has been performed as specified. In addition, all circuits shall be tested with

a cable tester capable of verifying the circuit under test. The minimum parameters to be reported are:

- Signal strength at outlet (not less than 0dBmV @ 55MHz, 301MHz, and 499MHz).
- CLI – not more than 20 microvolts per meter between 54MHz and 216MHz measured @ 3 meters.
- C/N – not less than 43 dB @ the highest channel.
- Hum – not more than 3%.
- Attenuation (not more than 5.65 dB per 100 feet @ 750 MHz for RG6 and not more than 3.65 dB per 100 feet @ 750 MHz for RG11).
- Characteristic Impedance must be 75 ohms.

 In the instance where any jack(s) fails the appropriate test, the Contractor shall repair the faulty circuit and retest. The Contractor shall provide the test equipment and perform these tests. The format of these test results shall include the complete jack i.d. (building number, outlet number and jack number) associated with the above parameters. This documentation (diskette) shall be provided to Tufts as part of the as-built information.

 In order to save time it is expected that the Contractor will have checked the workmanship and completely checked all connections prior to the acceptance test. Tufts shall approve the acceptance test method before testing begins. The Contractor may be required to repeat any tests which were performed without the approval of the Tufts Project Manager. The test shall be divided into discrete areas corresponding to the floors, and can be performed in any convenient order.

 In any area where the proportion of successful tests falls below 90% the acceptance test will be suspended and the Contractor will be required to correct the deficiency and to retest the remainder of the area. The test will be repeated from its beginning, in order to ensure that no circuits were damaged in the repair process.

## *31 AERIAL CABLE DESIGN & INSTALLATION*

### 31.1 GENERAL REQUIREMENTS

 All materials and equipment in an aerial design shall be manufactured, installed and tested as specified in the latest editions of applicable publications, standards, rulings and determinations of the following. If contradictions exist in these the most stringent will apply.

- ANSI – American National Standards Institute

- TIA/EIA – Telecommunications Industry Association/Electronics Industry Alliance, EIA-472-C Sectional Specification for Fiber Optic Communication Cables for Outside Aerial Use
- FCC – Federal Communications Commission
- BICSI – Telecommunications Distribution Methods Manual
- BICSI – Cabling Installation Manual
- NEC – National Electric Code
- NESC – National Electric Safety Code, Part 2 Sections 200-279 Safety Rules for the Installation and Maintenance of Overhead Electric Supply and Communication Lines.
- OSHA Safety Standards, Part 1926 Sections 955(a)(1) to (a)(18) Overhead Lines

 Provisions of all applicable federal, state, county and local laws, ordinances, regulations, rules, codes and orders shall be followed.

 Follow all requirements outlined in new or existing licenses and permits from Right of Way authorities and pole owner/s.

### 31.2 AERIAL CABLE DESIGN

 For all aerial fiber optic installations use Corning ALTOS cable.

 For all aerial copper installations use Superior Essex Alpeth

 Use the following as a guide for fiber cable length planning:

- Allow for enough cable slack on each cable end to reach the ground and into a splice vehicle plus 16’ at each splice point.
- Leave slack loops totaling 6% of the length of the cable run. Or at a minimum a 60’ loop shall be left at least every 1000’ and at every major road or railway crossing.
- The radius of the loop should be no smaller than the minimum bending radius of a loaded cable.
- Use ADSS snowshoes to store slack loops.

### 31.3 AERIAL CABLE INSTALLATION FOR LASHING TO NEW STRAND & OVERLASHING TO EXISTING

 Use Corning’s most current guide for “Lashing Aerial Installation of Fiber Optic Cable” along with the following requirements.

 Follow current requirements for clearances under NESC section 23.

 Fiber optic cable is a high capacity transmission medium which can have its transmission characteristics degraded when subjected to excessive pulling force, sharp bends, and crushing forces. Therefore extra care must be taken during the entire installation process. Contractor shall use extreme caution to protect all

existing cables and new cables being placed in aerial applications including but not limited to the following:

- Follow cable manufactures requirements for bend radius and pull tensions during installation.
- The lasher used to secure the cable to the strand must be of the correct size to lash the cable without damaging it. If it is undersized it will put periodic dents in the cable as it passes along the length. Use the following guidelines to choose proper size lasher:
  - H-Lasher for single or bundled cables 1 ½” or less in diameter.
  - C-Lasher for single or bundled cables up to 1 7/8” in diameter.
  - G-Lasher for single or bundled cables from 2 ½ to 5” in diameter.
  - J-Lasher for single or bundled cables up to 3” in diameter.
- Use any necessary equipment to properly support and protect cables including cable blocks, corner blocks, properly sized pulling grip, breakaway swivel, take up machine with tension and speed controls, pay off machine with an automatic or manual braking device, dynamometer to monitor cable tension where necessary.
- Cap all open cable ends during installation to prevent contamination from dirt or moisture.
- Knowing the span lengths, cable weight, and installation temperature refer to tables provided by cable manufacturer for proper sag and tension.
- Properly ground all metallic cable elements at splice points and at building entry points.
- Single lashing is adequate when installing cable on new strand.
- Double lashing is required over railways and roadways and when over-lashing to existing cables (see below for further requirements for over-lashing).
- Lashing wire should be terminated at each pole with a lashing wire clamp. In the event that a lashing wire is cut only one span of cable will be unsupported.
- Be sure to use an adequate number of cable blocks, spaced at a maximum of 50’ intervals, 25’ over roadways, with additional blocks placed over telephone drops, over all locations where a need is perceived by federal, state, local or company regulations or if the minimum bend radius of the cable is exceeded by any block.
- Do not lash the cable too tightly. Leave a small loop at each pole 2-4” below the strand for strain relief.

 Follow NESC rules to meet ice, wind and temperature load conditions for a “Heavy District” area. The maximum fiber stress under these conditions is limited to 12,500 psi. This limitation is necessary to help ensure a long service life in the presence of static fatigue.

 Permanent UV rated labels shall be affixed to fiber cables at every pole. Label should be stamped with “TUFTS UNIVERSITY FIBER”.

#### 31.4 ADDITIONAL REQUIREMENTS FOR AERIAL CABLE OVERLASHING

- 🔧 Over-lashing a fiber cable onto an existing aerial cable requires special consideration. The presence of a second cable increases the environmental load on the existing cable and strand without adding much strength to it.
  - Remove all straps and spacers from the existing cable bundle during lash-up. Metal ties may be reused, others shall be replaced.
  - Do not increase the tension in a strand to which a fiber optic cable is already lashed.
  - Double lash over existing cables.
  - Use cable blocks designed specifically for over-lash applications. Do not push cable blocks in front of the lasher as that may damage existing cables.

#### 31.5 AERIAL CABLE DOCUMENTATION

- 🔧 Contractor shall provide the following documentation:
  - As-built drawing/s with a record of the cable distance marks at every other pole location and at each cable end.
  - Documentation indicating cable tension along the route during installation.



**Appendix 1**

**Typical Alarm Configuration with Integrated Access Control (i.e. JumboFob)**

Note that this is a forward-moving configuration. Existing installations feature a standalone dual line communicator for the FACP.

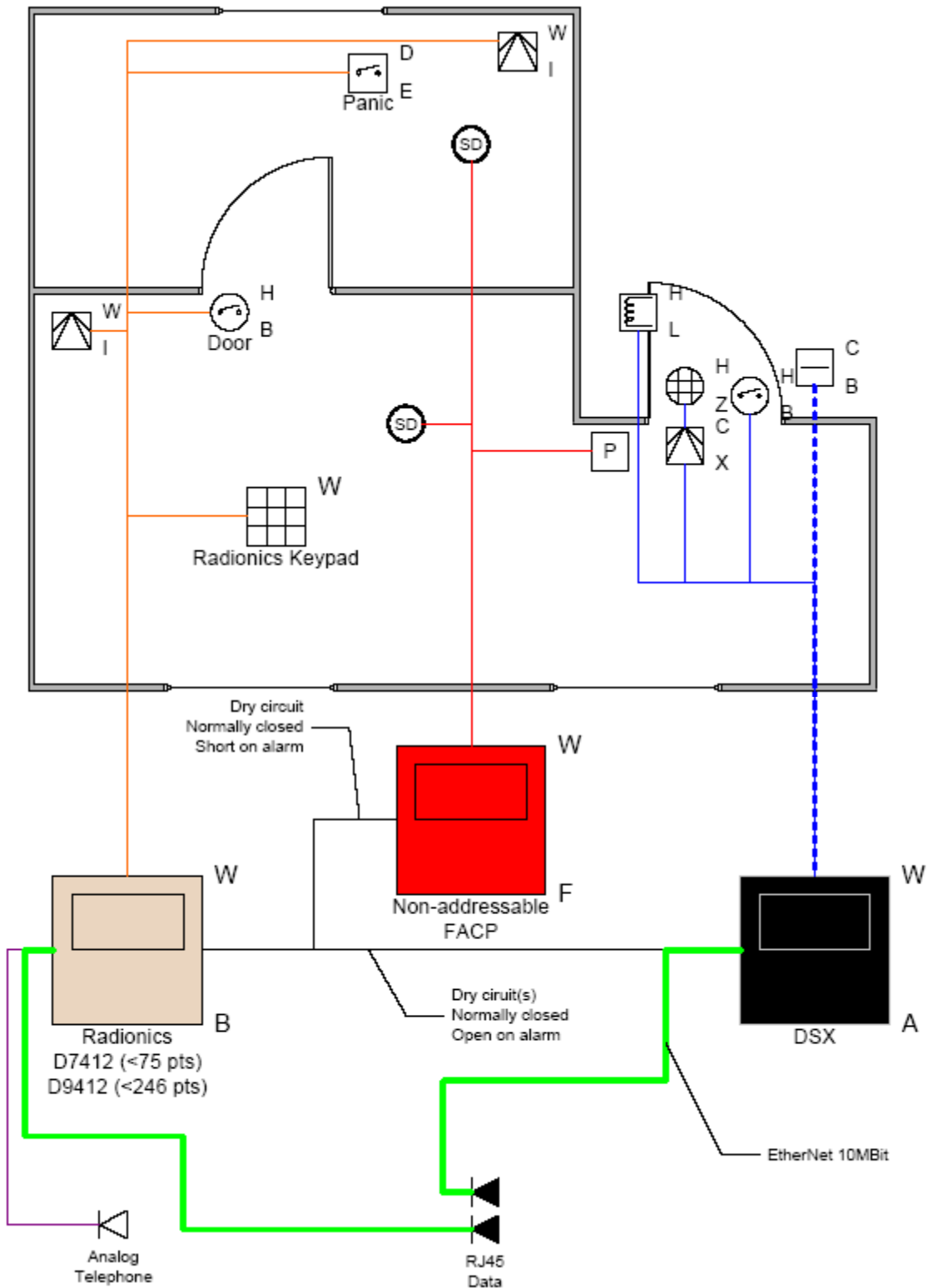

### Alarm Configuration Variations

The various permutations of alarm panels are depicted with their means of communication. These panels may be mixed, making communications requirements dynamic based on configuration.

